

OPERATOR'S MANUAL

Model 29

10 MHz DDS

Function Generator

WAVETEK

OPERATOR's MANUAL
Model 29
10 MHz DDS
Function Generator

© 1995 Wavetek

This document contains information proprietary to Wavetek and is provided solely for instrument operation and maintenance. The information in this document may not be duplicated in any manner without the prior approval in writing from Wavetek.

Wavetek
Instruments Division
San Diego, CA 92123
Tel: (1-619) 279-2200
(1-800) 223-9885
Fax: (1-619) 565-7942

Wavetek
11995 El Camino Real, Suite 301
San Diego, CA 92130
Tel: (1-619) 793-2300
Fax: (1-619) 565-7942

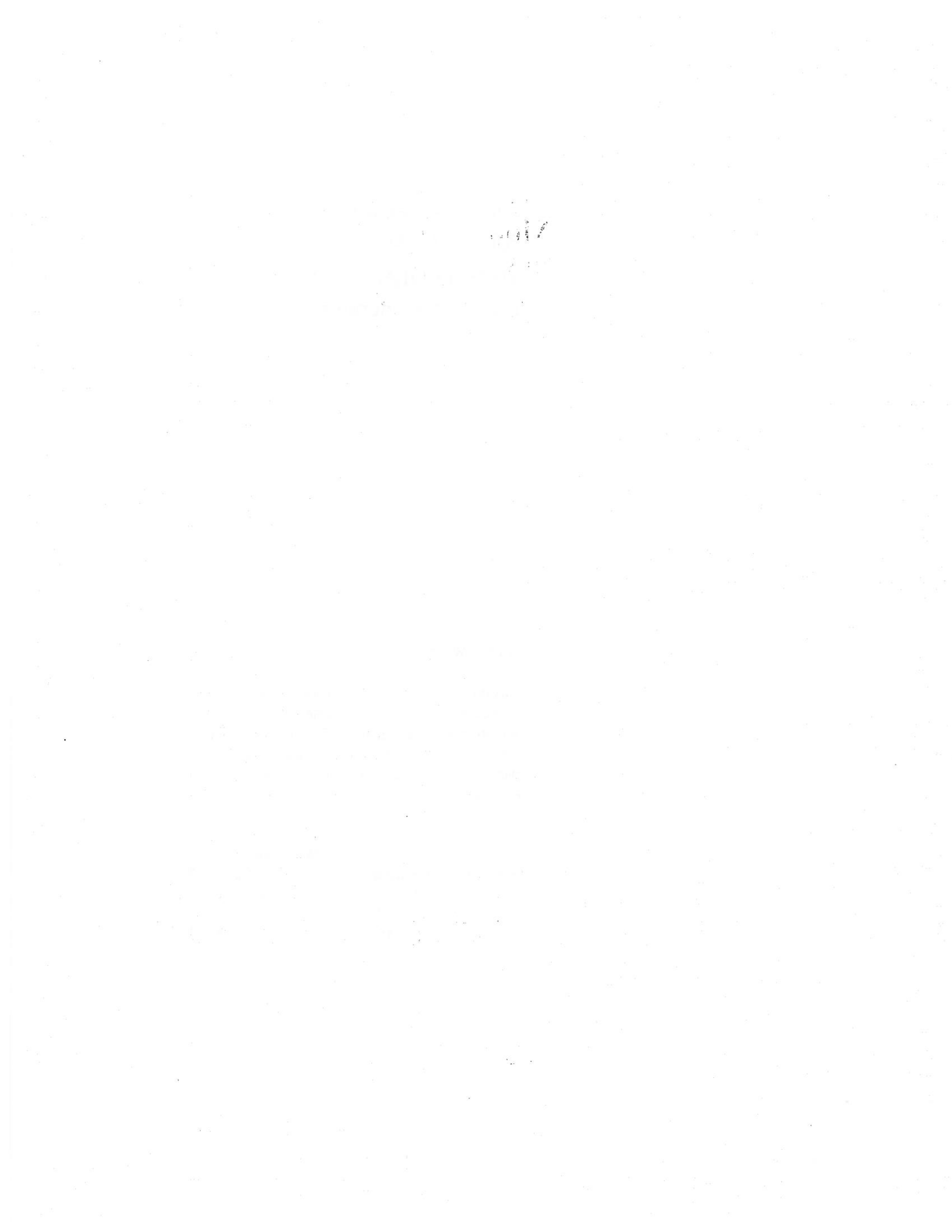

Table of Contents

Introduction	2
Specifications	4
Safety	8
EMC	9
Installation	9
Connections	11
Front Panel Connections	11
Rear Panel Connections	11
General Operation	13
Main Generator Operation	16
Main Generator Parameters	16
Warning and Error Messages	19
Auxiliary Output	21
Waveform Generation Options	21
Sweep Operation	24
Triggered Burst and Gate	27
Triggered Burst	27
Gated Mode	29
Amplitude Modulation	30
FSK	32
Special Waveforms	33
Staircase	33
Arbitrary	33
Noise	35
HOP	36
System Operations	38
Storing and Recalling Set-ups	38
System Settings	38
Synchronizing Generators	40
Calibration	42
Application Examples	44
DDS Operation and Further Waveform Considerations	48
Remote Operation	51
Remote Commands	61
Remote Command Summary	67
Appendix 1. Warning and Error Messages	70
Appendix 2. Factory System Defaults	72

Introduction

This Programmable Function Generator uses direct digital synthesis to provide high performance and extensive facilities at a breakthrough price. It can generate a variety of waveforms between 0.1MHz and 10MHz with a resolution of 7 digits and an accuracy better than 10ppm.

Direct digital synthesis for accuracy & stability

Direct digital synthesis (DDS) is a technique for generating waveforms digitally using a phase accumulator, a look-up table and a DAC. The accuracy and stability of the resulting waveforms is related to that of the crystal master clock.

The DDS generator offers not only exceptional accuracy and stability but also high spectral purity, low phase noise and excellent frequency agility.

A wide range of waveforms

High quality sine, square and pulse waveforms can be generated over the full frequency range of 0.1MHz to 10MHz.

Triangle waveforms, ramp waveforms and multi-level squarewaves can also be generated but with limitations as to the maximum useable frequencies.

Variable symmetry/duty-cycle is available for all standard waveforms.

Arbitrary waveform capability

Arbitrary waveforms can be loaded via the digital interfaces and then used in a similar way to the standard waveforms.

Up to five arbitrary waveforms of 1024 10-bit words can be stored in non-volatile memory. The waveform clock is 27.48MHz maximum.

This facility considerably expands the versatility of the instrument making it suitable for the generation of highly complex waveform patterns.

In addition, numerous "complex" waveforms are pre-defined in ROM, including commonly used waveshapes such as sine/x, exponentially decaying sinewave, etc.

Sweep

All waveforms can be swept over their full frequency range at a rate variable between 10 milliseconds and 15 minutes. The sweep is fully phase continuous.

Sweep can be linear or logarithmic, single or continuous. Single sweeps can be triggered from the front panel, the trigger input, or the digital interfaces. Two sweep markers are provided.

AM

Amplitude Modulation is available for all waveforms and is variable in 1% steps up to 100%. An internal AM source is incorporated. Alternatively modulation can be controlled from an external generator.

FSK

Frequency Shift Keying provides phase coherent switching between two selected frequencies at a rate defined by the switching signal source.

The rate can be set from dc to 50kHz internally, or dc to 1MHz externally.

Trigger/Burst & Gated

All waveforms are available as a triggered burst whereby each positive edge of the Trigger signal will produce one burst of the carrier, starting and stopping at the phase angle specified by the start-stop phase setting.

The number of cycles in the burst can be set between 0.5 and 1023. The Gated mode turns the output signal On when the gating signal is high and Off when it is low.

Both Triggered and Gated modes can be operated from the internal Trigger Generator (0.005Hz to 50kHz) or from an external source (dc to 1MHz).

Waveform Hop & Noise

The generator can be set up to 'hop' between a number of different waveform set-ups either at a pre-determined rate or in response to a manual trigger.

Up to 16 different hop waveforms can be defined in terms of frequency, amplitude, function, offset and duration, which is variable in 1ms steps up to 60s. The generator can also be set to simulate random noise within the bandwidth 0.3Hz to 700kHz with adjustable amplitude and offset.

Multiple phase-locked generators

The signals from the Clock In/Out socket and the Sync Out socket can be used to phase lock two or more generators.

This can be used to generate multi-phase waveforms or locked waveforms of different frequencies.

Easy and convenient to use

All of the main generator parameters are clearly displayed together on a backlit LCD with 4 rows of 20 characters. Sub menus are used for the modulation modes and other complex functions.

All parameters can be entered directly from the numeric keypad. Alternatively most parameters can be incremented or decremented using the rotary encoder.

This system combines quick and easy numeric data entry with quasi-analog adjustment when required.

Fully programmable

RS-232 and GPIB interfaces standard

The generator has, as standard, both RS-232 and GPIB interfaces which can be used for remote control of all of the instrument functions or for the down-loading of arbitrary waveforms; the GPIB interface conforms to IEEE-488.2.

AMPLITUDE MODULATION

Carrier Frequency Range 100 μ Hz to the maximum frequency for selected waveform.

Carrier Waveforms:	All
Depth:	Typically variable from 0% to 100% in 1% increments
Internal Source:	1 kHz fixed sinewave or 5 mHz to 50 kHz squarewave
External Source:	DC to 100 kHz (4 quadrant)
External Sensitivity:	Approximately 2 Vpp for 50% modulation

FREQUENCY SHIFT KEYING (FSK)

Phase coherent switching between two selected frequencies at a rate defined by the switching signal source.

Carrier Frequency:	100 μ Hz to the maximum frequency for selected waveform
Carrier Waveforms:	All
Switch Repetition Rate:	dc to 50 kHz (internal trigger generator) dc to 1 MHz (external trigger signal)
Switching Signal Source:	Internal from front panel key or internal trigger generator External from Trig/Gate input or remote interface

START/STOP PHASE

Phase relationship between MAIN OUT and AUX OUT is determined by the START/STOP PHASE setting.

Carrier Frequency:	100 μ Hz to 1 MHz
Carrier Waveforms:	All
Range:	0 to 360 degrees
Resolution:	1 degree

TRIGGER GENERATOR

Internal source 5 mHz to 50 kHz squarewave adjustable in 20 μ s steps with 3 digit resolution. Available for output at the sweep/marker connector (except during sweep or HOP operation).

OUTPUTS/INPUTS

FRONT PANEL CONNECTIONS

MAIN OUT	Waveform output at 50 Ω or 600 Ω (selectable) impedance. Short circuit protection for up to 60 seconds is provided.
AUX OUT:	CMOS/TTL level signal at the frequency and symmetry of main output. Phase relationship between MAIN OUT and AUX OUT is determined by the START/STOP PHASE setting.
EXT TRIG:	External trigger input for Trigger, Gate, Sweep and FSK operating modes. It is also used to synchronize one Model 29 (as a slave) to another Model 29 (as a master). Maximum input voltage is ± 10 V.

REAR PANEL CONNECTIONS

CLOCK IN/OUT	The function of the CLOCK IN/OUT connector is set from the front panel SYS (system) menu as follows:
CLOCK IN	The connector serves as an input for an external clock
CLOCK OUT	This is the default setting. The internal clock is made available as an output. When two or more Model 29s are synchronized the CLOCK OUT is used as a master to drive the CLOCK IN of the slave units.
PHASE LOCK	For use as a slave unit phase locked to the master unit.
VCA IN	Input connector for externally controlled Amplitude Modulation (AM). Impedance is nominally 6 k Ω .
SYNC OUT	When two or more generators are synchronized the SYNC OUT connector on the master generator is connected to the EXT TRIG inputs of the slave generators. SYNC OUT logic levels are nominally 0V and 5V with 50 Ω output impedance.
TRIG/SWEEP OUT	The function of this output is automatically determined by the generator operating mode. Except in sweep and HOP modes the output is that of the internal trigger generator, a fixed amplitude squarewave whose frequency is set in the TRIG of GATE menus. The rising edge of the trigger generator initiate trigger, gate and burst modes. In sweep mode the output is a 3-level waveform, changing from high (4V) to low (0V) at the start of the sweep, with narrow 1V pulses at marker points. In HOP mode the output goes low on entry to each waveform step and high after the new frequency and waveshape of that step have been set. Output impedance is 1k Ω .

INTERFACES

Full remote control facilities are provided through RS232 and IEEE-488 (GPIB) interfaces.

RS232:	Variable baud rate, 9600 baud max., 9-pin D connector.
IEEE-488:	Conforms with IEEE-488.1 and IEEE.488.2

STORED SETTINGS

Up to 9 complete instrument set-ups may be stored and recalled from battery backed memory.

GENERAL

Display:	20 character by 4 row alphanumeric display.
Size:	130 mm (height), 212 mm (width), 330 mm (depth)
Weight:	9 pounds (4.1 kg)
Power	115 V or 230 V nominal 50/60 Hz, adjustable internally, operating range $\pm 14\%$ of nominal, 30 VA maximum.
Operating Range:	5°C to 40°C, 20-80%RH
Storage Range:	-20°C to 60°C
Options:	19" Rack Mount Kit
Safety:	Complies with EN61010-1
EMC:	Complies with EN55011 and EN50082-1.

Safety

This function generator is a Safety Class I instrument according to IEC classification and has been designed to meet the requirements of EN61010-1 (Safety Requirements for Electrical Equipment for Measurement, Control and Laboratory Use). It is an Installation Category II instrument intended for operation from a normal single phase supply.

This instrument has been tested in accordance with EN61010-1 and has been supplied in a safe condition. This instruction manual contains some information and warnings which have to be followed by the user to ensure safe operation and to retain the instrument in a safe condition.

This instrument has been designed for indoor use in a Pollution Degree 1 environment (no pollution, or only dry non-conductive pollution) in the temperature range 5°C to 40°C, 20% - 80% RH (non-condensing). It may occasionally be subjected to temperatures between +5° and -10°C without degradation of its safety.

Use of this instrument in a manner not specified by these instructions may impair the safety protection provided. Do not operate the instrument outside its rated supply voltages or environmental range. In particular excessive moisture may impair safety.

WARNING! THIS INSTRUMENT MUST BE EARTHED

Any interruption of the mains earth conductor inside or outside the instrument will make the instrument dangerous. Intentional interruption is prohibited. The protective action must not be negated by the use of an extension cord without a protective conductor.

When the instrument is connected to its supply, terminals may be live and opening the covers or removal of parts (except those to which access can be gained by hand) is likely to expose live parts. The apparatus shall be disconnected from all voltage sources before it is opened for any adjustment, replacement, maintenance or repair.

Any adjustment, maintenance and repair of the opened instrument under voltage shall be avoided as far as possible and, if inevitable, shall be carried out only by a skilled person who is aware of the hazard involved.

If the instrument is clearly defective, has been subject to mechanical damage, excessive moisture or chemical corrosion the safety protection may be impaired and the apparatus should be withdrawn from use and returned for checking and repair.

Make sure that only fuses with the required rated current and of the specified type are used for replacement. The use of makeshift fuses and the short-circuiting of fuse holders is prohibited.

This instrument uses a Lithium button cell for non-volatile memory battery back-up; typical life is 5 years. In the event of replacement becoming necessary, replace only with a cell of the correct type, i.e. 3V Li/MnO₂ 20mm button cell type 2032. Exhausted cells must be disposed of carefully in accordance with local regulations; do not cut open, incinerate, expose to temperatures above 60°C or attempt to recharge.

Do not wet the instrument when cleaning it and in particular use only a soft dry cloth to clean the LCD window. The following symbols are used on the instrument and in this manual:-



Caution -refer to the accompanying documentation, incorrect operation may damage the instrument.



terminal connected to chassis ground.



mains supply OFF.



mains supply ON.



alternating current.

This function generator has been designed to meet the requirements of the EMC Directive 89/336/EEC.

Compliance was demonstrated by meeting the test limits of the following standards:

Emissions

EN55011 (1991) for industrial, scientific and medical (ISM) radio-frequency equipment; Group 1 Class B limits were applied.

Immunity

EN50082-1 (1992) Generic immunity standard for residential, commercial and light industry. Test methods and limits used were:

- a) EN60801-2 (1993) Electrostatic Discharge, 8 kV air discharge.
- b) IEC801-3 (1984) RF Field, 3 V/m.
- c) IEC801-4 (1988) Fast Transient, 1 kV peak.

Cautions

To ensure continued compliance with the EMC directive the following precautions should be observed:

- a) connect the generator to other equipment using only high quality, double-screened cables.
- b) after opening the case for any reason ensure that all signal and ground connections are remade correctly before replacing the cover. Always ensure all case screws are correctly refitted and tightened.
- c) In the event of part replacement becoming necessary, only use components of an identical type, see the Service Manual.

Installation

Check that the instrument operating voltage marked on the rear panel is suitable for the local supply. Should it be necessary to change the operating voltage, proceed as follows:

- 1) Disconnect the instrument from all voltage sources.
- 2) Remove the screws which retain the top cover and lift off the cover.
- 3) Change the transformer connections as follows:
 - for 230V operation connect the live (brown) wire to pin 15
 - for 115V operation connect the live (brown) wire to pin 14
- 4) Refit the cover and secure with the same screws.
- 5) To comply with safety standard requirements the operating voltage marked on the rear panel must be changed to clearly show the new voltage setting.
- 6) Change the fuse to one of the correct rating, see below.

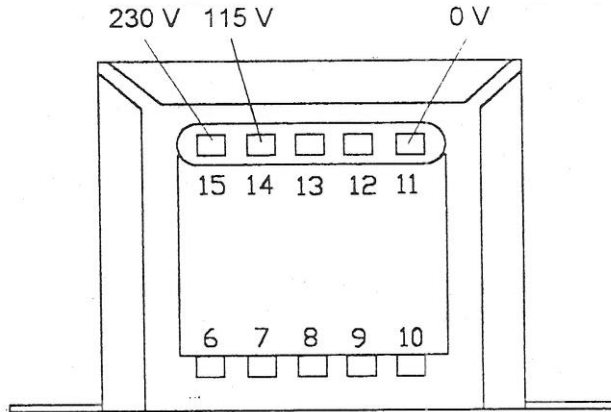

Fuse

Ensure that the correct mains fuse is fitted for the set operating voltage. The correct mains fuse types are:

for 230V operation: 250 mA (T) 250 V HRC

for 115V operation: 500 mA (T) 250 V HRC

To replace the fuse, disconnect the mains lead from the inlet socket and release the fuse drawer below the socket pins by depressing both clips together, with miniature screwdrivers, so that the drawer can be eased open. Change the fuse and replace the drawer.

The use of makeshift fuses or the short-circuiting of the fuse holder is prohibited.

Mains Lead

When a three core mains lead with bare ends is provided it should be connected as follows:-

Brown	-	Mains Live
Blue	-	Mains Neutral
Green / Yellow	-	Mains Earth

WARNING! THIS INSTRUMENT MUST BE EARTHED

Any interruption of the mains earth conductor inside or outside the instrument will make the instrument dangerous. Intentional interruption is prohibited. The protective action must not be negated by the use of an extension cord without a protective conductor.

Mounting

This instrument is suitable both for bench use and rack mounting. It is delivered with feet for bench mounting. The front feet include a tilt mechanism for optimal panel angle.

A rack kit for mounting one or two of these Half-width 3U high units in a 19" rack is available from the Manufacturers or their overseas agents.

Connections

Front Panel Connections

MAIN OUT

This is the 50Ω output from the main generator. It will provide up to 20V peak-to-peak e.m.f. which will yield 10V peak-to-peak into a matched 50Ω load. It can tolerate a short circuit for 60 seconds.



Do not apply external voltages to this output.

AUX OUT

This is a TTL/CMOS level output synchronous with MAIN OUT. Symmetry is the same as that set for the main output but the phase relationship between MAIN OUT and AUX OUT is determined by the PHASE setting specified on the TRIGger menu.

AUX OUT logic levels are nominally 0V and 5V from typically 50Ω. AUX OUT will withstand a short-circuit.



Do not apply external voltages to this output.

EXT TRIG

This is the external trigger input for Trigger, Gate, Sweep, FSK and HOP operating modes. It is also the input used to synchronise the generator (as a slave) to another (which is the master).



Do not apply external voltages exceeding ±10 V.

Rear Panel Connections

CLOCK IN/OUT

The function of the CLOCK IN/OUT socket is set from the SYStem menu as follows:

INPUT	The socket becomes an input for an external clock.
OUTPUT	This is the default setting. The internal clock is made available at the socket. When two or more generators are synchronized the 'master' is set to OUTPUT and the signal is used to drive the CLOCK IN inputs of the slaves.
PHASE LOCK	When two or more generators are synchronized the slaves are set to PHASE LOCK.

As an output the logic levels are nominally 1V and 4V from typically 50Ω. CLOCK OUT will withstand a short-circuit. As an input the thresholds is TTL/CMOS compatible.



Do not apply external voltages to this output exceeding +7.5 V or -2.5 V.

VCA IN

This is the input socket for external voltage controlled amplitude (VCA). Input impedance is nominally 6kΩ. Apply 2.5V for 100% level change at maximum output.



Do not apply external voltages exceeding ±10V.

SYNC OUT

When two or more generators are synchronized the SYNC OUT socket on the master generator is connected to the EXT TRIG inputs of slave generators.

SYNC OUT logic levels are nominally 0V and 5V from typically 50Ω. SYNC OUT will withstand a short-circuit.



Do not apply external voltages to this output.

TRIG/SWEEP OUT

The function of this output is automatically determined by the generator operating mode.

Except in sweep and HOP modes the output is that of the internal trigger generator, a fixed amplitude square-wave whose frequency is set on the TRIG or GATE menus. The rising edge of the trigger generator initiates trigger, burst, gate, etc.

In sweep mode the output is a 3-level waveform, changing from high (4V) to low (0V) at start of sweep, with narrow 1V pulses at each marker point.

In HOP mode the output goes low on entry to each waveform step and high after the new frequency and waveshape of that step have been set.

Output levels are nominally 0V and 4V from 1kΩ. TRIG/SWEEP OUT will withstand a short-circuit.



Do not apply external voltages to this output.

RS232

9-pin D-connector. The pin connections are shown below:

Pin	Name	Description
1	-	No internal Connection
2	TXD	Transmitted data from instrument
3	RXD	Received data to instrument
4	-	No internal connection
5	GND	Signal ground
6	-	No internal connection
7	RXD2	Secondary received data
8	TXD2	Secondary transmitted data
9	GND	Signal ground

Pin 2, 3 and 5 may be used as a conventional RS232 interface with XON/XOFF handshaking. Pins 7,8 and 9 are additionally used when the instrument is used in addressable RS232 mode. Signal grounds are connected to instrument ground. The RS232 address is set from the front panel using the REMOTE menu.

GPIB (IEEE-488)

The GPIB interface is not isolated; the GPIB signal grounds are connected to the instrument ground.

The implemented subsets are:

SH1 AH1 T6 TE0 L4 LE0 SR1 RL1 PP1 DC1 DT1 C0 E2

The GPIB address is set from the front panel using the REMOTE menu.

General Operation

This section is a general introduction to the features and organisation of the function generator intended to be read before using the instrument for the first time. Detailed operation is covered in later sections starting with Main Generator Operation.

DDS Principles

In this instrument waveforms are generated by Direct Digital Synthesis (DDS). One complete cycle of the waveform is stored in RAM as 1024 10-bit amplitude values. As the RAM address is incremented, the waveform values are output to a Digital-to-Analog Converter (DAC) which reconstructs the waveform. Sinewaves and triangles are subsequently filtered to smooth the steps in the DAC output. The frequency of the waveform is determined by the rate at which the RAM addresses are changed. Further details of how this rate is varied, i.e. how the frequency is changed, are given later in the DDS Operation section; it is sufficient to know that at low frequencies the addresses are output sequentially but at higher frequencies the addresses are sampled. The major advantages of DDS over conventional analog generation are:

- Frequency accuracy and stability is that of the crystal oscillator.
- Frequencies can be set with high resolution from mHz to MHz.
- Low phase noise and distortion.
- Very wide frequency sweeps are possible.
- Fast phase continuous frequency switching.
- Non-standard waveforms such as multi-level squarewaves are easily generated.
- Basic arbitrary waveform capability in the same instrument.

In addition, being a digital technique, it is easier to make every parameter programmable from the keyboard, or remotely via RS232 or GPIB interfaces.

The fundamental limitation of the DDS technique is that, as the generator frequency is increased, each waveform cycle is constituted from fewer samples. This is not a problem with sinewaves which, because they are filtered, can be produced with low distortion up to the frequency limit of the generator. With DDS squarewaves and pulse waveforms the 1 clock edge uncertainty sets a practical limit to the upper frequency. However, on this instrument the generation technique changes at 30kHz (but is overridable by the user) to use a comparator driven by the DDS sinewave; this ensures jitter-free squarewaves and pulses up to the frequency limit of the generator. Ramp and staircase waveforms are, by default, unfiltered (although filtering can be selected) and therefore become degraded above the frequencies indicated in the Specification; all waveforms are, however, available up to the maximum frequency of the generator.

Switching On

The power switch is located at the bottom left of the front panel.

At power up the generator displays the installed software revision whilst loading its RAM with waveforms; if an error is encountered the message "SYSTEM RAM ERROR, BATTERY FLAT?" will be displayed, see the Warnings and Error Messages section.

Loading takes a few seconds, after which the Main menu is displayed, showing the generator parameters set to their default values, with the MAIN OUT set off. Refer to the System Menu section for how to change the power up settings to either those at power down or to any one of the stored settings.

Change the basic generator parameters as described in the Main Generator Operation section and switch the MAIN OUT on with the OUTPUT key; the ON lamp will light to show that the

output is on. Note that AUX OUT, CLOCK OUT, etc. are always running and are not switched by the OUTPUT key.

Display Contrast

All parameter settings are displayed on the 20 character x 4 row backlit liquid crystal display (LCD). The contrast may vary a little with changes of ambient temperature or viewing angle but can be optimised for a particular environment by using the front panel contrast control. Insert a small screwdriver or trimmer tool through the adjustment aperture marked LCD and rotate the control for optimum contrast.

Keyboard

The keys can be considered in 7 groups:

- FUNCTION keys permit direct selection of the waveform function. Repeated presses of each of the 3 keys steps the function selection through each of the 2 or 3 choices associated with that key; the current selection is indicated by the illuminated lamp. Pressing a different key selects the function last selected with that key. In this way it is therefore possible to select between, for example, sine, square and triangle with single key presses, or between positive pulses and negative pulses, etc.
- SET keys permit direct selection of the four main generator parameters shown on the Main menu of the display, ready for value entries from the NUMERIC/UNIT keys.
- NUMERIC/UNIT keys permit direct entry of a value for the parameter currently selected; parameter selection is either directly (by the SET keys) for the main parameters, or by moving the cursor to the appropriate parameter in other menus. Thus to set a new frequency of 100kHz, for example press **FREQ/PER**, 1, 0, 0, kHz; or to change symmetry to 40%, press **SYMMETRY**, 4, 0, %.
- FIELD and DIGIT keys are used, together with the ROTARY CONTROL, to edit parameters on the current menu. Their use is explained more fully in the 'Principles of Editing' section below.
- MODE keys are used both to directly switch the respective mode (TRIG, GATE, AM, etc.) on or off and to select the menus for setting up these special functions. Alternate presses of a MODE key will turn the function on or off; when on the associated lamp is lit. Pressing the blue EDIT key followed by a MODE key displays the edit menu for that mode; the associated lamp flashes whilst the edit menu is displayed.
- UTILITIES keys give access to the STORE, RECALL and REMOTE parameter menus; the MAN/SYNC key is used for manual triggering and synchronizing two or more generators when suitably connected together.
- Lastly, the ENTER, ESCAPE, and CE (Clear Entry) keys have self-explanatory functions.

Numeric entries are automatically confirmed when the appropriate unit key (Hz, kHz, MHz, etc.) is pressed but ENTER can be used to enter a number in the parameter's basic units or to confirm entries with fixed units (e.g. phase) or no units (e.g. burst count). It is also used to confirm certain options when prompted.

Pressing ESCAPE returns a setting being edited to its last value; a second press (when appropriate) will return the display from an edit menu to the Main menu.

CE (Clear Entry) undoes a numeric entry digit by digit.

Further explanations will be found as appropriate in the detailed descriptions of the generator's functions.

Principles of Editing

FIELD and DIGIT keys are used, together with the rotary control, to edit parameters shown on the current menu. The Main menu shows all the basic generator parameters and is the one displayed unless editing of a special function has been selected. These edit menus are accessed by pressing the blue EDIT key, followed by the appropriate MODE key or a numeric key which has a secondary function printed in blue.

FIELD keys move the flashing edit cursor forward or backwards from one editable field to the next; all the digits of a numeric parameter value are treated as a single field. When the parameters of a particular function occupy two or more pages of the display, e.g. the sweep mode parameters, the further pages are indicated by MORE>>> shown in the display and the FIELD keys are also used to step between the end of one page and the start of another, and vice-versa. The attributes of the flashing edit cursor can be changed by the user if desired, see SYStem Menu section.

DIGIT keys operate in more than one mode. When a numeric parameter value field is selected by the FIELD keys, DIGIT keys step the edit cursor forward or backwards through the digits of the field. When the edit cursor is positioned in a parameter name (e.g. FREQ) pressing either digit key will step the parameter through each of the alternative forms in which a value may be entered (e.g. FREQ is changed to PERiod); the parameter numeric value and units change accordingly. Note that where there is no alternative form for the parameter (e.g. SYMMETRY) the edit cursor cannot be stepped into that field. When the edit cursor is positioned in a parameter selection field (e.g. SOURCE = on the TRIG menu), the DIGIT keys step through all possible choices for that parameter (e.g. SOURCE = TGEN, SOURCE = EXT, etc.) Lastly, when the edit cursor is positioned in the units field of a parameter value, the DIGIT keys increment or decrement the numeric value of the parameter by a factor of 10 each press; the units change each time the display autoranges.

The ROTARY CONTROL works as follows. With the cursor in any field other than a numeric value field turning the control acts in exactly the same way as pressing the DIGIT keys. With the edit cursor positioned anywhere in a parameter-numeric field, turning the control will increment or decrement the value; the step size is determined by the position of the edit cursor within the numeric field.

Thus for FREQ = 1.00000 MHz rotating the control will change the frequency in 1kHz steps. The display will auto-range up or down as the frequency is changed, **provided that autoranging permits the increment size to be maintained**; this will in turn determine the lowest or highest setting that can be achieved by turning the control. In the example above, the lowest frequency that can be set by rotating the control is 1 kHz, shown on the display as

FREQ = 1.000000 kHz

This is the limit because to show a lower frequency the display would need to autorange below 1kHz to

FREQ = xxx.xxx Hz

in which the most significant digit represents 100Hz, i.e. the 1kHz increment would be lost. If, however, the starting setting had been

FREQ = 1.000000 MHz

i.e. a 100 Hz increment, the display would have autoranged at 1kHz to

FREQ = 900.0000 Hz

and could then be decremented further right down to

FREQ = 000.0000 Hz

without losing the 100 Hz increment.

Turning the control quickly will step numeric values in multiple increments.

Main Generator Operation

When first switched on, and at all subsequent power-ups unless specified otherwise on the SYStem menu, the generator will be set to the factory defaults, with the output off. The basic parameters can be set from the Main menu as described below.

Main Generator Parameters

Frequency

```
FREQ=10.00000kHz
VhiZ=+20.0 Vpp 50Ω
DC=+0.00mV (+0.00mV)
SYM=50.0% (50.0%)
```

With the flashing edit cursor anywhere on the first line of the Main menu the frequency can be changed directly from the keyboard by entering the number and appropriate units only, e.g. 1kHz can be set by entering 1,kHz or ·, 0, 0, 1, MHz or 1, 0, 0, 0, Hz, etc. However, the display will always show the entry in the most appropriate engineering units, in this case 1.000000 kHz. By default, the maximum settable frequency for triangle, ramp, staircase and arbitrary waveforms is 100 kHz and an error message will be given if an attempt is made to enter a higher frequency with one of these waveforms selected, see Warning and Error Messages section. This frequency limit can be switched off, see 'Frequency Stop' in the Waveform Generation Options section, although signal quality for these waveforms will deteriorate progressively as the frequency increases, as discussed in the DDS Principles section. If this cursor is not already in a top line field it is first necessary to press the FREQ/PER key before making the number and unit entry. Note that this always returns the cursor to the parameter name field which can then be alternated between FREQ and PERiod with successive presses of either DIGIT key, or by turning the rotary control.

```
PER =100.0000us
VhiZ=+20.0 Vpp 50Ω
DC=+0.00mV (+0.00mV)
SYM=50.0% (50.0%)
```

When PER= shows in the display instead of FREQ=, the frequency can be set in terms of a period; enter the number and units (ns, μ s, ms or s) in the same way as for frequency. Note that the precision of a period entry is restricted to 6 digits; 7 digits are displayed but the last significant one is always zero. The hardware is always programmed in terms of frequency; when a period entry is made the synthesised frequency is the nearest equivalent value that the frequency resolution and a 6-digit conversion calculation gives. If the frequency is displayed after a period entry the value may differ by a digit from the expected value because of these considerations. Further, once the setting has been displayed as a frequency, converting back again to display period will give an exact 6-digit equivalent of the 7-digit frequency, but this may differ, by a digit, from the period value originally entered. If the edit cursor is moved to the numeric field, turning the rotary control will increment or decrement the numeric value in steps determined by the edit position within the field. The FIELD keys move the cursor to the field and the DIGIT keys move it within the field; this is more fully explained in the Principles of Editing section. Lastly, with the edit cursor in the units field, pressing the DIGIT keys or turning the rotary control will change the value in decade increments; the decimal point will move and/or the units will change as appropriate. Full 7-digit precision is maintained as the value is decremented until the 0.1mHz resolution limit of the instrument is reached; values which would have had least significant bits <0.1mHz are truncated with further decrements and the precision is consequently lost when the number is incremented again.

Output Level

The second line of the Main menu permits the output level to be set in terms of VhiZ (open circuit voltage) or V (potential difference into a matched load) or dBm (referenced to the specified source impedance). Both VhiZ and V can be set in terms of peak-peak volts (Vpp) or r.m.s. volts (Vrms). Note that in both cases the true peak-peak or r.m.s. values are shown for the selected waveform, even an arbitrary waveform. However, in the case of Vrms the DC Offset (see next section) is ignored in the calculation and must be taken into consideration by the user if the DC Offset is non-zero.

```
FREQ=10.00000kHz
VhiZ=+20.0 Vpp
50Ω
DC=+0.00mV (+0.00mV)
SYM=50.0% (50.0%)
```

The desired form of the output level display can be selected whilst the edit cursor is in the parameter name field by stepping through all the options with the DIGIT keys or the rotary control; bring the cursor to the parameter name field first, if necessary, by pressing AMPL, or by using the FIELD keys.

With the appropriate parameter form selected, the value is entered as a number followed by units, e.g. 100mV can be entered as 1, 0, 0, mV or ·, 1, V etc. The software acts intelligently in certain situations; for example, even if VhiZ or V is the selected parameter form, entering a number followed by the dBm key will cause the number to be entered as dBm. Similarly, with dBm as the selected parameter form, entering a number followed by V or mV will cause the number to be entered as V=Vrms. 0dBm is 1mW into the specified impedance; low signal levels are specified by using the +/- key to enter negative dBm. See also the last paragraph of this section for the use of the +/- key for output inversion.

Moving the edit cursor to the numeric field permits the set value to be varied by the rotary control in steps determined by the cursor position within the field. The FIELD keys move the cursor to the field and the DIGIT keys move it within the field; this is explained more fully in the Principles of Editing section.

Moving the edit cursor to the units field permits the numeric value to be changed in decade steps by the DIGIT keys or rotary control; the decimal point will move and/or the units will change as appropriate. Further increments are inhibited if the next decade step would take the value above the maximum level or below the minimum level. Decade stepping with the DIGIT keys or rotary control is also inhibited when the level is displayed in dBm.

Wherever the cursor is positioned on the second line of the display, alternate presses of the +/- key will invert the MAIN OUT output; if DC OFFSET is non-zero, the signal is inverted about the offset. The one exception to this is if the output level is specified in dBm; since low signals are specified in -dBm, the - sign is interpreted as part of a new output level entry and not as a command to invert the signal. The output level must be shown as a VhiZ or V value for the +/- key to operate as a signal invert key.

If an amplitude change is made which involves switching the attenuator, the output is switched off for 45ms whilst the change is made to prevent any transients appearing at the output.

Output Impedance

The impedance of the MAIN OUT output is selected in the last field of the second line. Move the edit cursor to this field and use the DIGIT keys or rotary control to toggle between 50Ω and 600Ω. The output level is unchanged but the displayed value in dBm will change because the 0dBm reference level (1mW into the specified impedance) changes with the impedance.

DC Offset

The DC Offset is set on the third line of the Main menu. With the cursor anywhere in the third line the DC offset can be changed directly from the keyboard by entering the number and appropriate units, e.g. 100mV can be set by entering 1, 0, 0, mV or -, 1, V, etc. If the cursor is not already in the third line of the display it is first necessary to press the DC OFFSET key, to position the cursor, before making the number and unit entry. Note that, unlike the FREQ= or VhiZ= parameter fields, the cursor does not move into the DC OFFSET name because it has no alternative.

With the edit cursor in the numeric field, turning the rotary control will increment or decrement the numeric value in steps determined by the edit cursor position within the field. The DC OFFSET or FIELD keys move the cursor to the field and the DIGIT keys move it within the field; this is more fully explained in the Principles of Editing section. Because DC offset can have negative values, the rotary control can take the value below zero; although the display may autorange to a higher resolution if a step takes the value close to zero, the increment size is maintained correctly as the offset is stepped negative. For example, if the display shows

DC = +205. mV

with the cursor in the most significant digit, the rotary control will decrement the offset in 100mV steps as follows:

DC = +205.mV

DC = +105.mV

DC = +5.00 mV

DC = -95.0 mV

DC = -195. mV

The +/- key can also be used at any time to set the offset value negative; alternative presses toggle the sign between + and -. Alternatively the sign of the offset can be changed as part of the entry of a new value, e.g. if the offset is +2.00V it can be changed to -100mV by pressing +/-, 1, 0, 0, mV.

The actual DC offset at the MAIN OUT socket is attenuated by the fixed-step output attenuator when this is in use. Since it is not obvious when the signal is being attenuated the actual offset is shown in brackets as a non-editable field to the right of the set value.

For example, in the display below, the pk-pk output is not attenuated by the fixed attenuator and the actual DC offset (in brackets) is the same as that set.

```
FREQ=10.00000kHz
VhiZ=+2.50 Vpp 50Ω
DC=+150.mV (+150.mV)
SYM=50.0% (50.0%)
```

If the output level is now reduced to 250mV pk-pk, which introduces the attenuator, the actual DC offset changes by the appropriate factor:

```
FREQ=10.00000kHz
VhiZ=+250.mVpp 50Ω
DC=+150.mV (+15.1mV)
SYM=50.0% (50.0%)
```

The above display shows that the set DC offset is +150mV but the actual offset is +15.1mV. Note that the actual offset value also takes into account the true attenuation provided by the fixed attenuator, using the values determined during the calibration procedure. In the example displayed the output signal is 250mV pk-pk exactly and takes account of the small error in the

-20dB fixed attenuator; the offset is 15.1mV exactly, taking account of the effect of the known attenuation (slightly less than the nominal -20dB) on the set offset of 150mV.

Whenever the set DC offset is modified by a change in output level in this way a warning message that this has happened will be displayed. Similarly, because the DC offset plus signal peak is limited to $\pm 10V$ to avoid waveform clipping, a warning message will be displayed. This is explained more fully in the Warnings and Error Messages section.

DC Output

The DC Offset control can be used to provide an adjustable DC output level if the waveform is off; the recommended set-up is as follows:

Select GATE edit mode and set the SOURCE to MAN/REMOTE. Exit edit mode and turn on GATE mode with the GATE key. Provided that GATE mode is not triggered, the MAIN OUT will now remain at the level set by the DC Offset control.

On the main menu set the output level to 1Vpp; this ensures that the software does not warn of clipping (output level too high) and that the output attenuator is not switched in (which would also attenuate the DC Offset). With the cursor in the DC Offset field the MAIN OUT can now be adjusted over the range $\pm 10V$ (open circuit).

Symmetry

Pressing the SYMMETRY key moves the flashing edit cursor directly to the symmetry numeric field on the bottom line of the display. This is the only field that can be edited; the bracketed field on the right-hand side shows the actual symmetry which might differ from that set if the set value is outside that permitted for the selected frequency and waveform combination, see Specification section. For example, in the display below the frequency is set to 100kHz and a squarewave is selected.

FREQ=100.0000kHz
VhiZ=+20.0 Vpp 50 Ω
DC=+0.00mV (+0.00mV)
SYM= <u>90.0</u> % (80.0%)

The symmetry is set to 90% but the actual symmetry is 80%, the limit for squarewaves and pulse waveforms above 30kHz.

The flashing cursor can be moved within the field using the DIGIT keys; turning the rotary control will then increment or decrement the setting in steps determined by the position of the cursor in the field.

Should the symmetry be set outside the permitted range for the selected frequency and waveform combination a warning message will be shown on the display, see Warnings and Error Messages section below.

Warning and Error Messages

Two classes of message are displayed on the screen when an illegal combination of parameters is attempted.

WARNING messages are shown when the entered setting causes some change which the user might not necessarily expect. Examples are:

1. Changing VhiZ from 2.5Volts pk-pk to 250mV pk-pk brings in the step attenuator; if a non-zero offset has been set then this will now be attenuated too. The message 'DC OFFSET CHANGE BY OUTPUT LEVEL' will be shown temporarily on the screen but the setting will be accepted; in this case the actual, attenuated, offset will be shown in brackets to the right of the set value.

-
2. With the output level set to 10V pk-pk, increasing the DC offset beyond $\pm 5V$ will cause the message 'DC OFFSET + LEVEL MAY CAUSE CLIPPING'. The offset change will be accepted (producing a clipped waveform) and the user may then choose to change the output level or the offset to produce a signal which is not clipped.
 3. With 100kHz squarewave selected, increasing symmetry beyond 80% will cause the message 'SYMMETRY TOO WIDE FOR FUNC/FREQ' to be displayed. The setting will be accepted but the actual symmetry will be limited to 80% as shown in the bracketed field beside the setting. If this out-of-specification setting is changed by reducing the frequency below 30kHz or by changing the waveform then the warning 'SYMMETRY CHANGED BY FUNC/FREQ' is displayed.

ERROR messages are shown when an illegal setting is attempted, most generally a number outside the range of values permitted. In this case the entry is rejected and the parameter setting is left unchanged. Examples are:

1. Entering a frequency of 100 MHz with any waveform selected, or 1MHz with triangle selected, etc. The error message 'FREQUENCY/PERIOD VAL OUT OF RANGE' is shown.
2. Entering a VhiZ of 25V pk-pk. The error message 'MAX OUTPUT LEVEL EXCEEDED' is shown.
3. Entering a DC offset of 20V. The error message 'MAX DC OFFSET EXCEEDED' is shown.

The messages are shown on the display for approximately two seconds. The last two messages can be viewed again by pressing the blue EDIT key followed by MSG (the 0 number key). Each message has a number and the full list appears in Appendix 1, together with some further explanation where the message is not entirely self-explanatory.

The default set-up is for all warning and error messages to be displayed and for a beep to sound with each message. This set-up can be changed on the ERRor menu, accessed by pressing the blue EDIT key followed by ERRor key (the 2 number key). The ERRor menu is shown below:

ERROR BEEP=ON
ERROR MESSAGE=ON
WARNING BEEP=ON
WARNING MESSAGE=ON

The flashing cursor can be moved through each of the four editable fields in turn using the FIELD keys. The field can then be toggled between ON and OFF, using the DIGIT keys or rotary control, to create the desired setting. If the new setting is required for future use it should be saved by changing the POWER UP= setting on the SYStem menu to POWER UP=POWER DOWN, see System Menu section.

Auxiliary Output

AUX OUT is a TTL/CMOS level output synchronous with MAIN OUT and with the same symmetry. However, the phase of the AUX OUT can be varied with respect to the MAIN OUT by changing the PHASE setting on the TRIGGER edit menu.

Auxiliary Output Phase

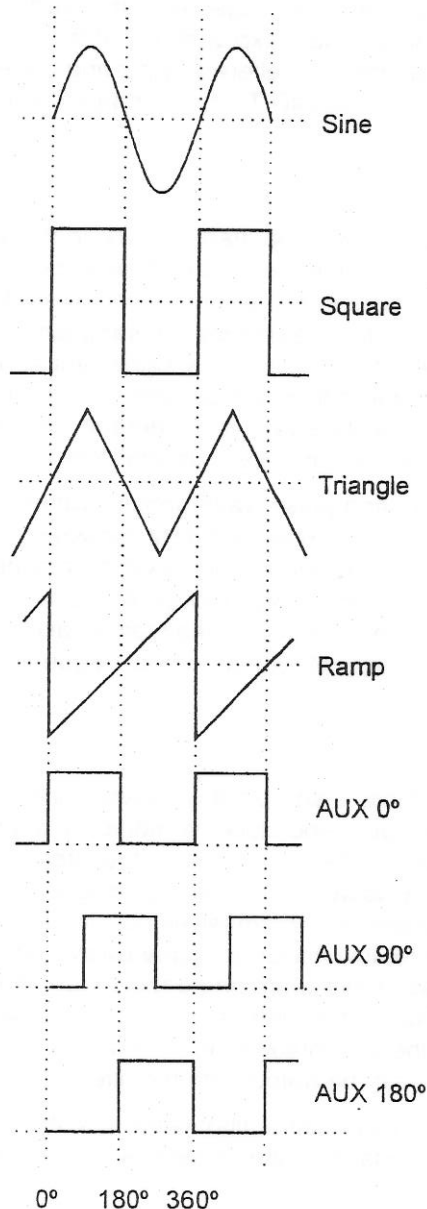

The convention adopted for phase in this instrument is illustrated in the diagram. 0° is always the first data point in waveform memory. On symmetrical waveforms 0° is the rising edge 'zero-crossing' point for sine, square, triangle and pulse waveforms; 0° is the start point of ramps, staircase and arbitrary waves. When the phase is set to 0° the rising edge of the AUX OUT squarewave is at 0° too. When the phase is set to a positive value, e.g. $+90^\circ$, the AUX OUT squarewave follows MAIN OUT by 90° , when the phase is set to a negative value AUX OUT leads MAIN OUT.

The phase is set by pressing the blue EDIT key followed by TRIG to select the trigger edit menu; the edit cursor is then moved to the PHASE field using the FIELD keys. PHASE can be entered directly from the keyboard, using the +/- key to change the sign if necessary, or by rotary control.

Above 30kHz the AUX OUT accompanying sine, triangle, square and pulse waveforms is automatically switched such that it is derived from the comparator (driven by the DDS sine wave) used to generate higher frequency MAIN OUT squarewaves and pulses; see the DDS Principles section for further information. This ensures a jitter-free AUX OUT signal up to the maximum frequency of the generator but means that phase shifting between MAIN OUT and AUX OUT is not then possible. However, this constraint can be removed by changing the setting on the OPTIONS menu from AUX OUTPUT=AUTO to AUX OUTPUT=LOW FREQ; the AUX OUT signal then continues to be generated independently, with phase adjustable with respect to the MAIN output, although the 1 clock (36ns) jitter will become increasingly significant at higher frequencies. Changing AUTO settings is described more fully in the next section, Waveform Generator Options.

The AUX OUT signal accompanying ramp, staircase and arbitrary waveforms is, by default, always generated independently; phase shift is adjustable across the frequency range but again clock jitter becomes increasingly significant at higher frequencies.

Waveform Generation Options

A number of parameters are, by default, switched automatically either when the frequency is set above 30kHz or when the operating mode is changed such that the best overall performance is achieved across the whole generator frequency range; see the DDS Principles section for further details of the 30kHz changeover. In addition, triangle, ramp, staircase and arbitrary waveforms are inhibited from being set above 100kHz, to ensure that they are not used accidentally at frequencies where the waveshape is noticeably deteriorating. In all cases,

however the default choice can be overridden by the user by changing the setting on the OPTions menu.

```
SQWAVE GEN=AUTO
FILTER=AUTO
AUX=AUTO  FSTOP=ON
SWEEP TGEN OUT=AUTO
```

The OPTions edit menu shown above is selected by pressing the blue EDIT key followed by OPTN (the shifted function of 1). The following descriptions, grouped together in this section for reference convenience, should be read in conjunction with the main explanations of the appropriate parameter elsewhere in this manual. Each parameter is altered by moving the edit cursor to the appropriate field with the FIELD keys and using the DIGIT keys or rotary control to change the setting.

Squarewave Generation

In LOW FREQUENCY mode the squarewave and pulse waves are generated digitally; in this way precision squarewaves can be generated down to very low frequencies without the edge uncertainty that would be associated with conventional ramp-and-comparator techniques. Above approximately 27kHz (clock frequency, 27.487MHz, ÷1024) the waveforms are sampled and the 1 clock (36ns) uncertainty introduces edge jitter which becomes increasingly significant at higher frequencies. In HIGH FREQUENCY mode the squarewave and pulses are derived from the output of a comparator driven by the DDS generated sinewave. The sinewave is, by default, filtered and jitter-free; the high frequency squarewave and pulse waveforms are thus jitter free too.

In AUTO mode (the default) the generation of squarewave and pulse waveforms is automatically switched from low to high frequency mode when the frequency exceeds 30kHz. However, when these waveforms are used in sweep and FSK modes, over a frequency range which includes the 30kHz changeover point, the generation mode will not change even though AUTO is selected. Instead, the mode in use before sweep or FSK are turned on is maintained across the frequency range; this can of course be overridden by selecting either high or low frequency mode on the Options menu, as described above.

Filter

The generator contains a 7-stage elliptical filter which exhibits a sharp cut-off beyond the maximum generator frequency, reducing intermodulation spurs and clock harmonics to a very low level. With the default condition of FILTER=AUTO set on the Option menu, the filter is switched in automatically for sine, triangle, high frequency squarewave and high frequency pulse waveforms (although the squarewave and pulse waveforms themselves do not pass through the filter); the filter is automatically switched out for low frequency squarewave and pulses, ramp, staircase and arbitrary waveforms because of the degrading effect it has on fast transitions in the waveform. However, for all these waveforms the filter can be set to be always on (FILTER=ON) or always off (FILTER=OFF); this has the advantage that, for example, an arbitrary waveform with an essentially sinusoidal content can be output with the filter on.

When Noise is selected, see Special Waveforms section, this 7-stage filter is always off, whatever the FILTER = setting, and a simple 700kHz low pass RC filter is switched in instead.

Auxiliary Output

When sine, triangle, squarewave or pulse waveforms are selected and with AUX OUTPUT=AUTO the auxiliary output squarewave generation switches automatically at 30kHz from DDS generation to a signal derived from a comparator driven by the DDS sinewave; the advantages of this approach are the same as those detailed previously in the Squarewave Generation section. However, as detailed in the Auxiliary Output Phase section, the high frequency generation mode has the disadvantage that a phase difference can no longer be set between AUX OUT and MAIN OUT. The automatic switchover at 30kHz can therefore be

overridden by setting AUX OUTPUT=LOW FREQUENCY, to maintain it in true DDS mode, or AUX OUTPUT=HIGH FREQUENCY to lock it in high frequency mode. With AUX OUTPUT=AUTO there is no automatic mode changeover if ramp, staircase or arbitrary waveforms are selected; high frequency mode can however be forced by setting AUX OUTPUT=HIGH FREQ.

Note that there is some second order interaction between the Squarewave Generation, Filter and Auxiliary Output settings which demand a little thought before deviations from the default conditions are defined. For example, if SQWAVE GEN and AUX OUTPUT options are set to AUTO but FILTER is set to OFF the edges of both the MAIN OUT and AUX OUT squarewaves will exhibit some jitter at high frequencies (e.g. 1MHz) because the sinewave driving the comparator from which both are derived will itself be jittery.

Frequency Stop

In the default mode of FSTOP=ON the maximum settable frequency for triangle, ramp, staircase and arbitrary is limited to 100kHz. Error messages will be shown if either an attempt is made to enter a frequency above 100kHz whilst one of these waveforms is selected, or if an attempt is made to select one of these waveforms with the frequency already set above 100kHz. This mode is useful in ensuring that frequencies are not accidentally set too high for waveforms whose quality will deteriorate above 100kHz. With FSTOP=OFF there are no frequency limits on these waveforms; waveform quality will however deteriorate progressively as the frequency increases for certain waveforms, as discussed in the DDS Principles section

Trigger/Sweep Output

With SWEEP/TGEN=AUTO the function of the rear panel TRIG/SWEEP OUT socket changes automatically when the operating mode is changed between Sweep, HOP and any other mode; the two functions of this output are described in the Connections section.

When SWEEP/TGEN=SWEEP is set the TRIG/SWEEP OUTPUT is always in the Sweep mode, if sweep is operational, or HOP mode if HOP is on; when SWEEP/TGEN=TRIG the TRIG/SWEEP OUTPUT always outputs the internal trigger generator signal. Note that, except when using the internal trigger generator in Trigger, Gate, FSK or AM modes, this signal is not synchronized with the main generator.

Sweep Operation

General

DDS operation gives the significant advantage over conventional function generators of phase-continuous sweeps over very wide frequency ranges, up to $10^{10}:1$. However, it must be remembered that the frequency is actually stepped, not truly linearly swept, and thought needs to be given as to what the instrument is actually doing when using extreme combinations of sweep time and frequency span, see Frequency Stepping Resolution section.

Sweep mode is turned on and off with alternate presses of the SWEEP key; the lamp beside the key lights when sweep mode is on. The sweep parameters (begin, end and marker frequencies, sweep direction, law, ramp time and source) are all set from the sweep edit menu which is selected by pressing the blue EDIT key followed by the SWEEP key. When sweep edit is selected the lamp beside the SWEEP key flashes to show edit mode regardless of whether sweep operation is selected to be on or off. The sweep mode parameters are set up on two pages of the display; the flashing edit cursor is moved around each page, and between pages, by the FIELD and DIGIT keys as described in the Principles of Editing section.

Return to the Main menu from either page of the edit menu is achieved by pressing the ESCAPE key.

See also the Squarewave Generation section for information concerning the use of sweep with squarewaves.

Connections for Sweep Operation

Sweeps are usually used with an oscilloscope or hard-copy device to investigate the frequency response of a circuit. The MAIN OUT is connected to the circuit input and the circuit output is connected to an oscilloscope or, for slow sweeps, a recorder.

To show the markers on the display instrument the rear panel TRIG/SWEEP OUT socket should be connected to a second channel; an oscilloscope should be triggered off this channel (negative edge) or the TRIG/SWEEP OUT can be connected directly to the external trigger of the oscilloscope if no marker display is required.

The TRIG/SWEEP OUT socket provides a 3-level waveform in sweep mode. The output changes from high (4V) to low (0V) at start of sweep and goes high again at end of sweep; it can therefore be used as a pen-lift signal (inverted by the user if necessary) if the display device is a chart recorder. Additionally the output provides narrow 1V pulses at each marker frequency, see Setting Sweep Span and Markers section.

For externally triggered sweeps, a trigger signal must be provided at the front panel EXT TRIG socket. A sweep is initiated by the rising edge of the trigger signal.

The generator does not provide a ramp output for use with X-Y displays or recorders.

Setting Sweep Span and Markers

Pressing the blue EDIT key followed by the SWEEP key displays the first page of the sweep parameters with values set to factory defaults.

```
BEG  FRQ=100.0000kHz
END  FRQ=10.00000MHz
MARK FRQ=5.00000MHz
      MORE->>>
```

The BEGIn, END, and MARKER frequencies can all be set or modified in exactly the same way as described for the setting of the frequency in the Main Generator section. In summary, with the cursor in the first field of any line, the DIGIT keys or rotary control will alternate the display between FRQ= and PER=; with the cursor in the numeric field the DIGIT keys will move the

cursor within the field and the rotary control will change the value in increments determined by the cursor position; with the cursor in the units field, the DIGIT keys or rotary control will change the value in decade increments. Direct keyboard entries (number plus units) will be accepted with the cursor anywhere in the line of the display. Note that if sweep mode is actually on (selected by alternate presses of the SWEEP key) and the ramp time is set to 200ms or less, then changing the BEGIn or END frequency causes the current sweep to be aborted, the frequency steps to be recalculated, and a new sweep started at each frequency change; it is therefore faster to make changes with the sweep off. The MARKER frequency, however, can be changed without interrupting the sweep.

A second marker is also displayed at the frequency set on the main menu, i.e. at the frequency set for the generator in non-sweep mode. This offers the advantage of a marker adjustable from the same menu used to control amplitude, offset, etc.

The marker signal is output from the rear panel TRIG/SWEEP OUT socket, see Connections for Sweep Operation section. The output is low (0V) for the duration of the sweep, with narrow 1V pulses at the marker frequency. Note that the marker pulse width is that of the duration of the frequency step with the closest value to the marker frequency. This means that sweeps with few steps will have wider markers than those with many steps, see Frequency Stepping Resolution section.

Setting Sweep Mode, Ramp Time and Source

Pressing the FIELD keys to move the cursor through each editable field of the first page of the sweep menu eventually steps the cursor onto the second page shown below.

MODE=BEG-END LAW=LOG
RAMP TIME=0.05 S
TRIG SRC=CONTINUOUS
MORE->>>

Pressing the left FIELD key with the cursor in the first (MODE) field will return the edit cursor to the last field on the first page of the sweep menu. Pressing the right FIELD key will step the cursor through all the editable fields up to TRIGger SouRCe; one more press returns the cursor to the first field of the first page. Pressing ESCAPE always exits the edit menu and returns to the Main menu.

With the edit cursor in the MODE field, alternate presses of the DIGIT keys, or turning the rotary control, will set the sweep direction to BEGIn-END or END-BEGIn. There are no restrictions on the BEGIn and END frequencies, e.g. the BEGIn frequency can be higher than the END frequency, so the MODE field simply provides an easy way to reverse the sweep direction.

With the edit cursor in the LAW field the sweep can be changed from LINear to LOGarithmic. With LAW=LIN set, the frequency changes linearly with time across the sweep; with LAW=LOG set, the frequency changes exponentially with time across the sweep. The term 'log sweep' is a convention; with the start frequency lower than the stop frequency (the usual mode of operation) the mathematical relationship of frequency to time is actually anti-log.

The sweep rate is set with the cursor in the RAMP TIME field; ramp time can be set with 3 digit resolution from 0.01s (10ms) to 999s. The choice of ramp time affects the number of discrete frequency steps in the sweep; faster sweeps will have fewer steps, see Frequency Stepping Resolution section.

The trigger mode of the sweep is set with the cursor in the TRIGger SouRCe field; the options are CONTINUOUS, EXTERNAL and MAN/REMOTE. In CONTINUOUS mode the sweep starts simultaneously with the high-to-low transition of the TRIG/SWEEP OUT signal; the sweep starts with the phase at 0° and at the output level set by the DC offset. At the end of the sweep the signal returns to this DC offset level and the TRIG/SWEEP OUT signal simultaneously goes high again. After a delay long enough for an oscilloscope to retrace, for example, the cycle repeats.

In EXTERNAL mode a trigger signal is connected to the front panel EXT TRIG socket. A sweep starts typically 200-800 μ s after the rising edge of the trigger signal; the sweep is completed before another trigger edge is recognised and a new sweep initiated. The minimum trigger pulse width is 1ms and the repetition rate should be $>(1.1 \times \text{sweep time} + 5)\text{ms}$.

In MAN/REMOTE mode a single sweep is initiated by each press of the MAN/SYNC key or by each remote command. If the MAN/SYNC key is pressed again during a slow sweep the sweep will be paused at the instantaneous sweep frequency until MAN/SYNC is pressed again to allow the sweep to continue.

Frequency Stepping Resolution

The generator frequency is stepped, not truly swept, between the BEGIN and END frequencies. The number of discrete frequency steps in a sweep is determined by the ramp time selected on the sweep edit menu; the size of each step, i.e. the frequency stepping resolution, is determined by the number of steps and the sweep span. For the fastest sweeps, 10ms to 200ms, the frequency steps are pre-calculated and output at 125 μ s intervals; this means that there are 80 discrete steps in a 10ms sweep, 160 in a 20ms sweep, and so on up to 1600 steps in a 200ms sweep. For slow sweeps, from $>200\text{ms}$ up to 999s, each frequency step is calculated on-the-fly and output every 5ms; this means that there are 100 steps in a 500ms sweep, 200 in a 1s sweep, and so on up to nearly 200,000 steps in a 999s sweep.

Note that at the fastest sweep rates, with fewest frequency steps (e.g. 10ms sweep) two effects can occur at extremes of frequency span which are not experienced with conventional generators. Firstly, if the scan is very wide the frequency changes will be quite large at each step; if the output is applied to a filter, for example, the response will be a succession of step-change levels with (at higher frequencies) many cycles of the same frequency at each step. Secondly, if the begin frequency is less than 800Hz (the ramp rate for fast sweeps), one or more of the low frequency steps will contain incomplete cycles. In part, of course, these effects can only be created because of the very wide sweeps that can be achieved with DDS techniques; analog generators usually have more restricted capabilities.

Note also that because the marker pulse duration (from the rear panel TRIG/SWEEP OUT socket) is that of the nearest frequency step, fast sweep rates with few steps will have wider marker pulses.

Triggered Burst and Gate

In Burst mode a defined number of cycles are generated following each trigger event. This mode is edge triggered.

In Gated mode the generator runs whenever the gating signal is high. This mode is level sensitive.

Both Burst and Gated modes can be controlled by either the internal trigger generator, an external trigger input, by the front panel MAN/SYNC key or by remote control.

Internal Trigger Generator

The internal trigger generator divides down a crystal oscillator to produce a 1:1 square-wave with a period from 0.02ms (50kHz) to 200s (0.005Hz). Generator period entries that cannot be exactly set are accepted and rounded up to the nearest available value, e.g. 0.109ms is rounded to 0.12ms. The generator output is available as a TTL level signal at the rear panel TRIG/SWEEP OUT socket.

In Burst mode the rising edge of each cycle of the trigger generator is used to initiate a burst; the interval between bursts is therefore 0.02ms to 200s as set by the generator period.

In Gated mode the output of the main generator is gated on whilst the trigger generator output is high; the duration of the gate is therefore 0.01ms to 100s in step with trigger generator periods of 0.02ms to 200s.

External Trigger Input

External trigger or gate signals are applied to the front panel EXT TRIG input which has a TTL level (1.5V) threshold. In Triggered Burst mode the input is edge sensitive; the rising edge of each external trigger initiates the specified burst. In Gated mode the input is level sensitive; the output of the main generator is on whilst the gate signal is high (>1.5V).

The minimum pulse width that can be used with the EXT TRIG input is 50ns and the maximum repetition rate is 1MHz. The maximum signal level that can be applied without damage is $\pm 10V$.

Triggered Burst

Triggered Burst mode is turned on and off with alternate presses of the TRIG key; the lamp beside the key lights when triggered mode is on. The triggered mode parameters (trigger source, internal trigger generator, burst count and start/stop phase) are all set from the trigger edit menu which is selected by pressing the blue EDIT key followed by the TRIG key. When trigger edit is selected the lamp beside the TRIG key flashes to show edit mode regardless of whether triggered burst operation is currently selected to be on or off.

SOURCE=EXT
TGEN=1.00ms 1.000kHz
BURST COUNT= 0001
PHASE=+000° (+000°)

Trigger Source

With the edit cursor in the SOURCE field of the trigger edit menu, the DIGIT keys or rotary control can be used to select EXTERNAL, MAN/REMOTE, or internal Trigger GENERATOR as the trigger source.

With the source set to EXTERNAL, the specified burst is triggered by the rising edge of a trigger signal applied to the EXT TRIG input, see External Trigger Input section. With the source set to MAN/REMOTE, a burst can be initiated by pressing the front panel MAN/SYNC key or by the appropriate command via the RS232 or GPIB interfaces.

With the source set to TGEN, the burst is triggered internally as described in the Internal Trigger Generator section. The period of the internal generator is set in the TGEN field on the second line of the edit menu. With the cursor in the numeric field the DIGIT keys will move the cursor within the field and the rotary control will change the value in increments determined by the cursor position; with the cursor in the units field the DIGIT keys or rotary control will change the value in decade increments. Direct keyboard entries (number plus units) will be accepted with the cursor in either field. Beside the generator period value the equivalent frequency is shown; this is for information only and is not an editable field.

Because the internal trigger generator can be used by the trigger, gate, FSK and AM functions, and can be set from their respective edit menus, an information field is displayed in brackets beside TGEN when this is selected as the source. This field will show [FREE] when TGEN is not used elsewhere, or any of the letters [G,F,A,T] to indicate that the generator is currently set as the source on the GATE, FSK, AM, or TRIG menus respectively, in addition to the menu currently displayed.

Burst Count

The number of complete cycles in each burst following the trigger is set with the edit cursor in the BURST COUNT field. Entries can be made direct from the keyboard or by rotary control; the burst range is 1 to 1023 with a resolution of 1 cycle or 0.5 to 511.5 with a resolution of 0.5 cycles. The first cycle starts, and the last cycle stops, at the phase set in the PHASE field.

Start/Stop Phase

The start and stop phase of the triggered burst is set in the PHASE field. The PHASE field actually sets the phase of the Auxiliary Output and it is from this output that control of the start and stop point of the main generator is derived; the rising edge of the AUX OUT signal, which can be phase shifted with respect to the MAIN OUT, determines the start and stop point of the main waveform burst. Consequently, the conditions under which the Auxiliary Output phase shift is constrained, and which are fully explained in that section, all apply to start/stop phase. For example, the start/stop phase of sine and triangle waveforms cannot be adjusted for main output frequencies above 30kHz unless the AUX OUTPUT field on the Options menu is set to LOW FREQUENCY generation mode because only in this mode does the AUX OUT continue to be phase shifted with respect to MAIN OUT.

Because the phase control signal is derived from the Auxiliary Output waveform further considerations apply as the main generator frequency is increased. With AUX OUTPUT= LOW FREQ on the Options menu phase shift control is still available above 30kHz but real hardware delays become increasingly significant such that the start/stop phase increases for no change in phase setting; this shift is caused by the delay between AUX OUT and MAIN OUT becoming more significant and by the delays in the burst count and phase control circuit themselves. These delays can be equivalent to say a +45° phase shift at 1MHz; however, by 'backing off' the required phase shift by -45° the desired condition can still be achieved. At the same time, however, the fewer samples making up each cycle of the waveform means that the start/stop point becomes an uncertain 'band' which is 1 clock wide.

Note that these effects apply even when the phase is set to 0°; at frequencies approaching 10MHz the phase shift can be 90° or more and the uncertainty band becomes wide. Because this effect is seen at 0° phase it is also evident when AUX OUTPUT is in HIGH FREQUENCY mode, i.e. when there is no phase control. In fact, because the AUX OUT signal is derived from the filtered DDS sinewave in this mode the filter adds further phase delay, creating even longer phase shifts at a given frequency than are evident with AUX OUTPUT in LOW FREQUENCY mode.

In summary, phase errors and uncertainty will increase as the main frequency is increased above 30kHz, even with 0° phase set. However, stop/start phase control can be used, with care, to much higher frequencies by 'backing-off' the phase to compensate for the hardware delays.

Gated Mode

Gated mode is turned on and off with alternate presses of the GATE key; the lamp beside the key lights when gate mode is on. The selection of the gate source signal is made from the gate edit menu which is selected by pressing the blue EDIT key followed by the GATE key. when gate edit is selected the lamp beside the GATE key flashes to show edit mode regardless of whether gate operation is currently selected to be on or off.

SOURCE=EXT
TGEN=1.00ms 1.000kHz

Gate Source

With the edit cursor in the SOURCE field of the gate edit menu, the digit keys or rotary control can be used to select EXTERNAL, MAN/REMOTE, or Trigger GENERATOR as the gate source. In all cases, when the gate condition is true, the main generator signal is gated through to the MAIN OUT socket. Since the main generator is free-running and not synchronized with the gate source the start and stop phase of the waveform is entirely arbitrary; there will be an instantaneous transition from/to the DC Offset level to/from the current waveform phase at the start/stop of the gating period.

With the source set to EXTERNAL, the generator waveform is gated on whilst the external signal applied to the EXT TRIG input exceeds the gate threshold (1.5V), see External Trigger Input section.

With the source set to MAN/REMOTE, the generator waveform is 'toggled' on and off with alternate presses of the MAN/SYNC key or by the appropriate commands via the RS232 or GPIB interfaces.

With the source set to TGEN, the generator waveform is gated on as explained in the Internal Trigger Generator section; the trigger generator is set exactly as described in the Trigger Source section.

Amplitude Modulation

Two modes of operation are available from the AM menu:

- Amplitude Modulation using the Internal Trigger Generator as the modulation source in which the modulation depth is expressed as a percentage and constant modulation depth is maintained as the main generator (carrier) amplitude is varied.
- VCA (Voltage Controlled Amplitude) mode, in which the main generator amplitude is directly proportional to the external modulating signal voltage applied to the rear panel VCA IN socket. Suppressed carrier modulation (SCM) is achievable in this mode.

AM mode is turned on and off with alternate presses of the AM key; the lamp beside the key lights when AM mode is on. The AM parameters are all set from the AM edit menu which is selected by pressing the blue EDIT key followed by the AM key. When AM edit is selected the lamp beside the AM key flashes to show edit mode regardless of whether AM mode is currently selected to be on or off.

```
SOURCE=EXT VCA
TGEN=1.00ms 1.000kHz
INT MOD DEPTH=030%
INT MOD=SQUARE
```

Amplitude Modulation (Internal)

With the edit cursor in the SOURCE field of the AM edit menu the DIGIT keys or rotary control can be used to toggle the source between EXT VCA and TGEN (Trigger Generator) i.e. between external VCA mode and internal AM mode.

Modulation Frequency

Select TGEN in the SOURCE field and move the cursor to the TGEN field to set the period of the Internal Trigger Generator, the modulation source for internal AM. The internal trigger generator produces a squarewave with a period that can be set from 0.02ms (50kHz) to 200s (0.005Hz). Period entries that cannot be exactly set are accepted and rounded up to the nearest available value, e.g. 0.109ms is rounded to 0.12ms. The generator output is available as a TTL level signal at the rear panel TRIG/SWEEP OUT socket.

Beside the generator period value the equivalent frequency is shown; this is for information only and is not an editable field. Because the internal trigger generator can be used by the trigger, gate, FSK and AM functions, and can be set from their respective menus, an information field is displayed in brackets beside TGEN when this is selected as the source. This field will show [FREE] when TGEN is not used elsewhere, or any of the letters [G, F, A, T] to indicate the generator is currently set as the source on the GATE, FSK, AM, or TRIG menus respectively, in addition to the menu currently displayed.

Modulation Depth

Move the edit cursor to the INT MOD DEPTH field to set the modulation depth between 1% and 100% in 1% increments. The maximum output (20Vpp open circuit) cannot be exceeded and clipping will occur if modulation attempts to drive the output beyond this limit. The maximum generator output setting at which correct operation is maintained reduces from 20Vpp to 10Vpp (open circuit) as the modulation is increased from 0% to 100%.

Modulation Waveform

The default modulation waveform is squarewave because this permits the full frequency range of the internal trigger generator to be used. Alternatively, a fixed 1kHz sinewave can be selected by moving the edit cursor to the INT MOD field in the last line of the display; the DIGIT keys or

rotary control can be used to toggle the setting between SQUARE (at the frequency set on the internal trigger generator) and SINE. Note that selecting SINE forces the TGEN field to display 1.00ms 1.000kHz but the user setting is not lost and if INT MOD= SQUARE is reselected the TGEN setting returns to its original value.

VCA (External)

With the cursor in the SOURCE field of the AM edit menu, set the source to EXT VCA. Connect the modulating signal to the rear panel VCA IN socket (nominal $6k\Omega$ input impedance); a positive voltage increases the generator output and a negative voltage decreases the output. Note that as with internal AM, clipping will occur if the combination of generator setting and VCA signal attempts to drive the output above 20Vpp (open circuit).

External AM is achieved by setting the generator to the required output level and applying the modulation signal (which can be AC coupled if required) at the appropriate level to obtain the modulation depth required. If the generator output level is changed the amplitude of the modulating signal will have to be changed to maintain the same modulation depth. As with internal AM, the maximum output setting of the generator at which clipping is avoided is reduced from 20Vpp to 10Vpp (open circuit) as modulation is increased from 0% to 100%. Modulation frequency range is DC to 100kHz.

The generator's amplitude control circuit has four quadrant operation, allowing the generator output to be inverted if the external VCA voltage is taken sufficiently negative. Suppressed carrier modulation (SCM) can be achieved by applying a modulating signal with a negative offset between 0V and -3V (depending on output level setting) sufficient to reduce the carrier output to zero.

It is also possible to modulate a DC level from the generator with a signal applied to VCA IN, as follows. Set the generator to 0Hz sine wave on the Main menu and +90° phase on the Trigger menu. Select EXT TRIG (the default) and turn Trigger mode on with the TRIG key but do not apply a trigger signal. The MAIN OUT is now set at the peak positive voltage defined by the amplitude setting on the Main menu; setting -90° phase on the Trigger menu will give the peak negative voltage. Select EXT VCA on the AM edit menu and turn AM on; the DC level will now be modulated by the signal applied to the VCA IN socket.

FSK (Frequency Shift Keying) mode permits fast phase-continuous switching between two frequencies. All other parameters of the waveform (amplitude, offset, symmetry) remain the same as the frequency is switched; for switching between waveforms where all parameters can change, refer to HOP.

FSK can be controlled by either the internal trigger generator, an external trigger input, by the front panel MAN/SYNC key or by remote control.

FSK mode is turned on and off with alternate presses of the FSK key; the lamp beside the key lights when FSK mode is on. The FSK mode parameters (frequencies, trigger source and internal trigger generator) are all set from the FSK edit menu which is selected by pressing the blue EDIT key followed by the FSK key. When FSK edit is selected the lamp beside the FSK flashes to show edit mode regardless of whether FSK mode is currently selected to be on or off.

```
FREQ A=10.00000kHz
FREQ B=10.00000MHz
SOURCE=EXT
TGEN=1.00ms 1.000kHz
```

Frequency Setting

The two frequencies, FREQ A and FREQ B, between which the waveform is switched are set in exactly the same way as the frequency on the Main menu; in fact, FREQ A is the main generator frequency in non-FSK mode and changing FREQ A on the FSK edit menu will also change the frequency shown on the Main menu.

Trigger Source

With the edit cursor in the SOURCE field of the FSK edit menu, the DIGIT keys or rotary control can be used to select EXTERNAL, MAN/REMOTE, or internal Trigger GENERATOR as the trigger source which controls the frequency shifting.

With the source set to EXTERNAL the frequency is switched at each rising edge of the signal applied to the EXT TRIG input. The minimum pulse width that can be used with the EXT TRIG input is 50ns and the maximum repetition rate is 1MHz.

With the source set to MAN/REMOTE, the frequency is switched with each press of the front panel MAN/SYNC key or by the appropriate command via the RS232 or GPIB interfaces.

With the source set to TGEN, the frequency is switched at each rising edge of the internal trigger generator; the trigger generator produces a squarewave with a period that can be set from 0.02ms (50kHz) and 200s (.005Hz). Period entries that cannot be exactly set are accepted and rounded up to the nearest available value, e.g. .109ms is rounded to .12ms. The generator output is available as a TTL level signal at the rear panel TRIG/SWEEP OUT socket.

Setting the frequency of the internal trigger generator is fully described in the Trigger Source section of TRIGGERED BURST AND GATE. Because the internal trigger generator can be used by the trigger, gate, FSK and AM functions, and can be set on their respective edit menus, an information field is displayed in brackets beside TGEN when this is selected on the source. This field will show [FREE] when TGEN is not used elsewhere, or any of the letters [G, F, A, T] to indicate that the generator is currently set as the source on the GATE, FSK, AM, or TRIG menus respectively in addition to the menu currently displayed.

Special Waveforms

Staircase

Staircase, or multilevel squarewaves, are selected by pressing the STAIR key; when STAIR is selected the lamp beside the key lights. The default staircase is a 4-level waveform with level changes at 90° intervals; to modify or define a new staircase select the staircase edit menu by pressing the blue EDIT key followed by STAIR. When staircase edit is selected the lamp beside the STAIR key flashes to show edit mode; selecting edit mode always sets staircase on and symmetry to 50% to permit visual checking of the waveform.

```
VALS=ABS  AUTO=YES  
STEP=00  ACTIVE  
LENGTH=0256  
LEVEL=+511
```

The staircase edit menu is shown above. Up to 16 steps can be defined (numbered 00 to 15) with a length and level specified either in absolute terms or as a percentage of full scale height and cycle length. When the value is set to ABSolute in the VALS field the LENGTH field will accept numbers in the range 0000 to 1024 (the cycle sample length) and the LEVEL field will accept values in the range -512 to +511, i.e. 10-bit resolution peak-peak; -512 and +511 correspond to -10V and +10V peaks respectively with the amplitude on the Main menu set to maximum but note that the actual peak-peak voltage will be determined by the actual amplitude setting. When the value is set to %MAX in the VALS field both the length and level fields will accept numbers in the range 0 to 100% in 1% steps.

To edit the staircase, or create a new one, proceed as follows. Move the cursor to the STEP field and use the keyboard or rotary control to select the first step to be changed; note that the level of the selected step is dithered during editing to provide a visual check that the correct step is being changed. Move the cursor to the LENGTH field and use the keyboard or rotary control to enter the new length for that step in the appropriate units; press ENTER to enter the value. If the AUTO field has been left set at YES (the default value) the cursor will automatically move to the LEVEL field; enter a value in the appropriate units and press ENTER again. The cursor will move back to the LENGTH field and the STEP field will be incremented by 1 ready for the next entry. If AUTO has been set to NO, the stepping between LENGTH and LEVEL and the incrementing of the STEP must be done manually.

The staircase waveform is made up from steps 00, 01, 02 ... etc., in numeric order, up to the step whose length brings the total to 1024 or more samples; all these steps, including any in the sequence that have zero length, will be flagged as ACTIVE beside their step number in the display because changing the LENGTH or LEVEL of any of them will affect the waveform. Those steps beyond the last active step will be flagged INACTIVE, even if they have a non-zero length, because changing them will not affect the waveform. If the length of the last active step takes the total number of samples above 1024 then the surplus samples are ignored (but the full length is displayed); if the last active sample has insufficient samples to bring the total to 1024 then the end of the waveform is filled in with the necessary number of samples at LEVEL=000.

Waveform editing forces the symmetry to 50% to simplify entry; when edit mode is ended the waveform symmetry will return to that specified on the Main menu.

Arbitrary

Up to 5 user-defined arbitrary waveforms can be down-loaded via the RS232 or GPIB interfaces and stored, together with a 16-character name in non-volatile RAM; these waveforms occupy stores 01 to 05 inclusive. Stores 06 onwards contain a number of frequently used arbitrary waveforms stored in ROM.

Each arbitrary waveform is stored as 1024 points each with a value in the range -512 to +511, i.e. 10-bit vertical resolution; -512 and +511 correspond to -10V and +10V peaks respectively with amplitude on the Main menu set to maximum. However, the actual waveform 'played back' from the generator can have its amplitude, offset and symmetry adjusted as if it was a basic sine, square, etc., waveform.

The currently recalled arbitrary waveform is selected by pressing the ARB key; the lamp beside the ARB key lights to show that arbitrary mode is selected. The ARB edit menu is used to change the currently recalled arbitrary waveform, to store new waveforms in non-volatile RAM and to name them. The arbitrary edit menu is accessed by pressing the blue EDIT key followed by ARB. When ARB edit is selected the lamp beside the ARB key flashes to show edit mode regardless of whether ARB mode is currently selected to be on or off.

```
RECALL ARB NO: 14
                SINX/X

ENTER TO EXECUTE
```

Recalling Arbitrary Waveforms

The default ARB edit menu is shown above. With the edit cursor in the store number field each store can be stepped through in turn using the rotary control or direct keyboard entry. Each stored waveform from ROM will have a reference name in the second line of the display, e.g. sine x/x; the user-defined waveforms in non-volatile RAM will have the names given by the user during the store procedure, see next section.

To recall a particular waveform select the appropriate number and press ENTER. Once the waveform has been recalled into waveform memory it can be selected by pressing the ARB key and output at the frequency, amplitude, offset and symmetry defined on the Main menu.

Storing Arbitrary Waveforms

User defined waveforms can be downloaded into non-volatile RAM via the RS232 or GPIB interface; details are given in the Remote Control section.

Arbitrary waveforms created from the front panel, e.g. staircase waveforms, can be saved to non-volatile RAM using the ARB edit menu. With the edit cursor in the first edit field of the menu, alternate presses of the DIGIT keys will switch the field between RECALL and STORE.

```
STORE ARB NO: 01

ENTER TO EXECUTE
```

Pressing ENTER changes the menu to permit a name to be entered for the waveform. Turning the rotary control scrolls through all available characters in the selected digit position; the DIGIT keys are used to move the cursor to each digit position in turn.

```
SAVE ARB TO STORE 01
NAME: USE DIGIT/DIAL
WAVE_
ENTER TO EXECUTE
```

The display above shows the name WAVE entered; when the name is complete, pressing ENTER saves the waveform and name in the specified store. A confirmation beep is given and the display returns the menu to 'RECALL ARB No: nn', when nn is the store number just saved.

Noise

The generator can be set to output pseudo-random noise within the bandwidth 0.03Hz to 700kHz. To achieve this bandwidth a simple RC filter is always switched in instead of the standard 7-stage filter, whatever the FILTER = setting is on the Options menu, see Waveform Generation Options section. Amplitude and offset are adjustable and Noise can be used in GATE and AM modes.

Noise is selected from the Noise menu, accessed by pressing the blue EDIT key followed by NOISE, the shifted function of 4. Noise is turned on and off with alternate presses of the DIGIT keys or by turning the rotary control. When Noise is on, the lamp beside the last used FUNCTION will go off and no other function (including STAIR and ARB) can be selected.

Having set Noise on, pressing ESCAPE will return the instrument to the Main menu; the FREQUENCY field will show FREQ = WIDEBAND NOISE. Normal entries from the keyboard can in fact be made in the frequency field but the new value will not be used until Noise is turned off again. Similarly the symmetry setting can be changed while Noise is on but it will have no effect until Noise is turned off again.

The other parameters on the Main menu can, however, be changed normally, i.e. amplitude, offset and output impedance. Noise can also be used in the same way as any other waveform in GATE and AM modes; attempting to switch on any other mode will bring up the warning message "Operation is illegal here", although normal editing of all modes is still permitted.

HOP

The HOP facility allows up to 16 different waveforms to be output in sequence at a rate determined by either the internal timer, an external trigger, a remote command or by pressing the MAN/SYNC key. Each waveform can be set to any waveshape, frequency, amplitude and offset; symmetry is the same for every step in the sequence and is defined on the Main menu before HOP is selected. Frequency only changes are phase-continuous.

HOP is both edited and controlled from the HOP menu, accessed by pressing the blue EDIT key followed by HOP (the shifted function of the 5 key). Return to the Main menu is by pressing ESCAPE.

Setting Each Waveform Step

The HOP menu is shown below. With the HOP field set to HOP:OFF the edit cursor can be moved around all the editable fields using the FIELD and DIGIT keys in the standard way.

```
HOP:OFF n=01 01.000s
FREQ=10.00000kHz
VhiZ =+20.0 Vpp
SINE
DC=+0.00mV LAST=01
```

The 16 steps are numbered 00 to 15. The step to be edited is selected with the edit cursor in the n= field using direct keyboard entries, followed by ENTER, or the rotary control.

For each step the frequency, amplitude and offset are set up, having positioned the cursor in the appropriate field, exactly as for the Main menu; the cursor can be moved directly to the fields of interest by pressing the FREQ/PER, AMPL, or DC OFFSET keys as appropriate. For further information see the Main Generator Parameters section. The other parameters of the Main menu, symmetry and output impedance, are set on that menu and are the same for every HOP waveform.

The waveshape for each step is selected directly with the standard FUNCTION keys or with the cursor in the edit field to the right of the amplitude display. The DIGIT keys or rotary control can be used to step through each choice in turn; the corresponding lamp beside the FUNCTION key lights to confirm the selection. The currently loaded STAIRcase and ARbitrary waveforms are also included in the selection sequence (between -RAMP and SINE) and their lamps also light when selected.

All parameters can be copied from one step to the next step by entering the new step in the n= field and pressing RECALL; the differences in the new step can then be entered as described above. This provides a quick means of creating new steps when only 1 or 2 parameters change.

Defining the Sequence and Timing

All 16 steps always contain a set-up, even if this is only the default setting. When set to run the HOP sequence will start at step 00 and execute steps in chronological order up to the step number defined in the LAST= field, after which it will go back to step 00 and start again; the desired sequence should therefore be set starting at step 00 and the LAST= field should be set to the last valid step number.

Both the control mode (internal, external or manual/remote) and internal timing (if selected) are set with the edit cursor in the rightmost field of the top line of the display; the diagram shows the default setting of 1s internal interval. Note that each step can be set to a different length or a **different mode**; it is therefore possible to mix internally timed steps with externally triggered or manually initiated steps. The internal timer can be set from 2ms to 65s in 1ms increments using the rotary control or direct keyboard entry; see Timing Considerations section for further information. With the interval set to 00.002s (2ms), further anticlockwise movement of the rotary

control will select EXTERNAL then MANUAL; alternatively they can be directly selected from the keyboard by entering 1ms and 0ms, respectively. In EXTERNAL mode the sequence is stepped on at each rising edge of the trigger signal connected to the front panel EXT TRIG socket. In MANUAL mode the sequence is stepped on with each press of the MAN/SYNC key or appropriate remote command.

A synchronizing signal is provided at the rear panel TRIG/SWEEP OUT socket. At the entry to each step the signal goes low, followed by a rising edge after the frequency and waveshape have changed for the new step. However, the rising edge will generally occur **before** an amplitude or offset change (if specified) has been completed, see Timing Considerations section.

Running the Sequence

To run the HOP sequence the edit cursor must be positioned in the HOP field; alternate presses of the DIGIT keys will then toggle HOP between ON and OFF. With HOP:ON the edit cursor is suppressed and no editing is possible. Exiting HOP, by pressing ESCAPE, automatically sets HOP:OFF and returns the generator to the setting used before HOP was selected.

When HOP is running the HOP display will show the waveform parameters for each step which is manually stepped or has a duration >500ms; the display will not track the changes of shorter steps or externally triggered steps.

Timing Considerations

The time to set up the waveform at each step will depend on the nature of the change. The approximate timings for each change, from the trigger edge, are as follows:

- Frequency only: 0.5ms. Frequency changes are phase-continuous.
- Frequency and waveshape: 3ms, but longer if the filter is switched as well.
- Amplitude and Offset: Up to 40ms.

If the new amplitude setting involves an attenuator change the output is switched off for 45ms whilst the change is made to prevent any transients appearing at the output.

The synchronizing signal at the rear panel TRIG/SWEEP OUT socket is a low-going pulse whose falling edge occurs at the start of each step; this is about 1ms after an external trigger. The rising edge occurs just after the completion of a frequency or waveshape change, i.e. 0.5ms or 3ms later respectively. For an amplitude and/or offset change the rising edge occurs slightly later but well before the 40ms delay needed to guarantee the change has been completed; however, if the amplitude change causes the attenuator to be switched, the rising edge **will** occur after the attenuator has changed and the output has been switched back on.

The set **duration** of the step is timed from the rising edge of the synchronizing signal at the TRIG/SWEEP OUT socket. The minimum step duration of 2ms can be used for frequency only changes but the time needed to implement waveshape/amplitude/offset changes determines a practical minimum which is greater than this. Recommended times are >10ms for frequency plus waveshape changes and >50ms for amplitude and offset changes. If a shorter duration than that recommended above is set the results will be unpredictable and it is likely that HOP cannot be turned off in the usual way. To recover from this situation hold the ESCAPE key down for ~1s until HOP mode is exited.

Saving HOP Settings

The current HOP setting is saved in non-volatile memory at power-down. It is not part of the data saved by the STORE function (see Storing and Recalling Set-ups section) and therefore only one complete HOP sequence can be stored. The HOP setting is not lost when the system defaults are reloaded.

System Operations

Storing and Recalling Set-ups

Complete waveform set-ups can be stored to or recalled from non-volatile RAM using the STORE and RECALL menus.

To store a set-up, press the STORE key in the Utilities section of the keyboard; the display shows the following message:

```
SAVE TO STORE NO: 1

ENTER TO EXECUTE
```

Nine stores, numbered 1 to 9 inclusive, are available. Select the store number using the rotary control or direct keyboard entry and press ENTER to execute the store function.

To recall a set-up, press the RECALL key; the display shows the following:

```
RECALL STORE NO: 0

0 FOR DEFAULTS
ENTER TO EXECUTE
```

In addition to the user-accessible stores numbered 1 to 9, store 0 contains the factory defaults which can be reloaded in the same way.

Note that loading the defaults does not change the HOP set-up or any of the other set-ups stored in memories 1 to 9.

System Settings

This section deals with a number of system settings which can be changed to suit the user. These are the cursor style, the power-up setting and rotary control status. In addition, the function of the rear panel CLOCK IN/OUT socket is set from this menu.

```
CURSOR CHAR=0 [-]
DIAL=UNLOCKED
POWER UP=DEFAULTS
CLOCK BNC=OUTPUT
```

Cursor Style

The edit cursor style can be selected with the cursor in the CURSOR CHAR field. The default style is to alternate between the screen character and underline [-]; the alternatives are a solid rectangle, an open rectangle and a blank. Use the rotary control to select the required style.

Rotary Control

The default condition for the rotary control is UNLOCKED, i.e. active. Set the DIAL field to LOCKED using the DIGIT keys to make the rotary control inactive.

Power Up Setting

With the cursor in the POWER UP field the setting can be changed from POWER UP = DEFAULTS (the default setting) to POWER UP = POWER DOWN (i.e. settings at power down are restored at power up) or POWER UP = any of the settings stored in non-volatile memories 1 to 9. POWER UP = DEFAULTS restores the factory default settings, see Appendix 2.

Clock In/Out Setting

The function of the rear panel CLOCK IN/OUT socket is determined by the setting in the CLOCK BNC field.

With CLOCK BNC = OUTPUT (the default setting) a buffered version of the internal clock is made available at the CLOCK IN/OUT socket. When two or more generators are synchronized the 'master' is set to OUTPUT and the signal is used to drive the CLOCK IN/OUT of 'slaves'.

With CLOCK BNC = INPUT the socket becomes an input for an external clock.

With CLOCK BNC = PHASE LOCK the generator is in 'slave' mode and CLOCK IN/OUT socket must be driven by a 'master' generator set to CLOCK BNC=OUTPUT.

Because setting 'slave' mode cancels any gate, trigger, sweep or FSK mode currently running, a warning message is shown when this option is selected and it is necessary to press ENTER to execute; pressing ESCAPE will return the setting to INPUT or OUTPUT.

Further details are given in the Synchronizing Generators section.

Synchronizing Generators

Two or more generators can be synchronized together following the procedure outlined below; the number of generators that can be linked in this way will depend on the clocking arrangement, cable lengths, etc., but problems should not be experienced with up to 4 generators.

Synchronizing Principles

Frequency locking is achieved by using the clock output from the 'master' generator to drive the clock inputs of 'slaves'. The additional connection of an initialising SYNC signal permits each slave to be synchronized such that the phase relationship between master and slave outputs is that specified on each slave generator's Trigger menu.

Synchronization is only possible between generators when the ratio of the master and slave frequencies is rational, e.g. 3kHz can be synchronized with 2kHz but not with 7kHz. The most practical use of synchronization will be to provide outputs at the same frequency, or maybe harmonics, but with phase differences.

Connections for Synchronization

The preferred clock connection arrangement is for the rear panel CLOCK IN/OUT of the master (which will be set to CLOCK OUTPUT) to be connected directly to each of the CLOCK IN/OUT sockets of the slaves (which will be set to PHASE LOCK). The alternative arrangement is to 'daisy-chain' the slaves from the master using a BNC T-piece at each slave connection but reflections can cause clock corruption at the intermediate taps under some circumstances.

Similarly the preferred synchronizing connection is from the rear panel SYNC OUT of the master directly to each of the EXT TRIG inputs of the slaves. The alternative arrangement is to 'daisy-chain' from each SYNC OUT to the next generator's EXT TRIG in turn; this does not give rise to any data integrity problems but cumulative hardware delays will worsen the phase-shift accuracy.

Generator Set-ups

Each generator can have its main parameters set to any value, with the exception that the ratio of frequencies between master and slave must be rational, see Synchronizing Principles section. Each generator can be set to any waveform.

The phase relationships between the slaves and the master are set individually on the Trigger menus of each slave, exactly as described in the Triggered burst section. The convention adopted in Synchronized mode is that a negative phase setting **delays** the slave output with respect to the master; for example, a phase setting of -90° will delay the slave by a quarter-cycle with respect to the master. If the slave's EXT TRIG inputs are all driven directly from the master then all phase shift is referenced from the master; thus 4 generators set to the same frequency with the 3 slaves set to -90° , -180° and -270° respectively will give four evenly spaced phases of the same signal. If, however, the synchronizing signal was daisy-chained from each SYNC to the next generator's EXT TRIG then the phase shifts become cumulative and each slave must be set to -90° phase to achieve the same result.

Hardware delays become increasingly significant as frequency increases causing additional phase delay between the master and slaves. However, these delays can be largely nulled-out by 'backing-off' the phase settings of the slaves.

The phase setting on each slave affects the AUX OUT phase as described in the Auxiliary Output section. Note though that the phase setting for synchronization purposes is not subject to the same waveform dependent frequency limitations as AUX OUT.

The individual modes for the master and slaves are set in the CLOCK BNC field of the SYStem menu, see System Settings section. The master is set to CLOCK BNC = OUTPUT and all the slaves are set to CLOCK BNC = PHASE LOCK.

Synchronizing

Having made the connections and set up the generators as described in the preceding paragraphs, synchronization is achieved by pressing the MAN/SYNC key of each slave in turn. Once synchronized only the clock connections need be maintained; however, any change to the set-up of a slave, e.g. a phase change, will cause synchronization to be lost as the waveform memory is rewritten with the new phase, etc., and re-synchronization will be necessary.

Calibration

All parameters can be calibrated without opening the case, i.e. the generator offers 'closed-box' calibration. All adjustments are made digitally with calibration constants stored in EEPROM. The calibration routine requires only a DVM and a frequency counter and takes no more than a few minutes.

The crystal in the timebase is pre-aged but a further ageing of up to ± 5 ppm can occur in the first year. Since the ageing rate decreases exponentially with time it is an advantage to recalibrate after the first 6 month's use. Apart from this it is unlikely that any other parameters will need adjustment.

Calibration should be carried out only after the generator has been operating for at least an hour in normal ambient conditions.

Equipment Required

- 3½ digit DVM with 0.25% DC accuracy and 0.5% AC accuracy at 1kHz.
- Frequency counter capable of measuring 10.00000MHz and $50\mu\text{s} \pm 0.1\mu\text{s}$ pulsewidths.

The DVM is connected to the MAIN OUT and the counter to the AUX OUT.

Frequency meter accuracy will determine the accuracy of the generator's clock setting and should ideally be ± 1 ppm.

It may be quicker to use an oscilloscope for steps 05 and 15 (see next section).

Calibration Procedure

The CALibration procedure is accessed by pressing the blue EDIT key followed by CAL, the shifted function of 6. At each step the display changes to prompt the user to adjust the rotary control or FIELD/DIGIT keys, until the reading on the specified instrument is at the value given. The FIELD keys provide very coarse adjustment, the DIGIT keys coarse adjustment and the rotary control fine adjustment. Pressing ENTER increments the procedure to the next step; pressing CE decrements back to the previous step. Alternatively, pressing ESCAPE exits to the last CAL display at which the user can choose to either keep the new calibration values (ENTER), return to the old values (ESCAPE) or restart the calibration procedure (CE).

The first two displays (CAL 00 and CAL 01) specify the connections and adjustment method. The subsequent displays, CAL 02 to CAL 20, permit all adjustable parameters to be calibrated. The full procedure is as follows:

CAL 02	Zero DC Offset.	Adjust for 0V ± 5 mV
CAL 03	DC Offset +ve full scale.	Adjust for 10V ± 20 mV
CAL 04	DC Offset -ve full scale.	Check for -10V ± 20 mV
CAL 05	Multiplier zero offset.	Adjust for minimum
CAL 06	Waveform offset.	Note reading (DCV)
CAL 07	Waveform offset.	Adjust for CAL 06 reading ± 10 mV
CAL 08	Waveform DC offset.	Adjust for 0V ± 5 mV
CAL 09	Waveform full scale.	Adjust for 10V ± 10 mV
CAL 10	Squarewave full scale.	Adjust for 10V ± 10 mV
CAL 11	-20dB attenuator.	Adjust for 1V ± 1 mV
CAL 12	-40dB attenuator.	Adjust for 0.1V ± 0.1 mV
CAL 13	-12dB intermediate attenuator.	Adjust for 1.768V AC ± 5 mV

CAL 14	-20dB intermediate attenuator.	Adjust for 0.707V AC \pm 1mV
CAL 15	AM squarewave zero.	Adjust for minimum output
CAL 16	AM squarewave full scale.	Adjust for 10V \pm 10mV
CAL 17	AM sinewave full scale.	Adjust for 3.54 VAC \pm 10mV
CAL 18	HF squarewave symmetry (50%)	Adjust for 50 μ s \pm 0.1 μ s
CAL 19	HF squarewave symmetry (75%)	Adjust for 75 μ s \pm 0.1 μ s
CAL 20	Clock calibrate.	Adjust for 10.00000MHz at MAIN OUT or 27.48779MHz at rear panel CLOCK IN/OUT. Adjust to \pm 1ppm.

Press ENTER twice to store new values and exit calibration mode.

Application Examples

Some examples of the many waveforms that can be generated by this instrument are given in the following sections. To make the examples a useful means of gaining familiarity with the generator, numeric values have been chosen which are convenient for displaying the waveforms on an oscilloscope.

To work through the examples connect MAIN OUT from the generator to the input of the 'scope through a 50 Ω terminator.

Default Settings

There are many ways of configuring the waveform, trigger or modulation settings which might result in the instrument appearing not to work. Under these circumstances the simplest means of restoring operation is to recall the default settings by pressing **RECALL, 0, ENTER**, followed by **OUTPUT ON** to turn the Main Out on.

Simple Main Generator Operation

With the Main menu displayed, press

FREQ, 1, kHz
EMF, 1, 0, V

and select **SINE** on the **FUNCTION** keys. If the **OUTPUT** lamp is not lit, press **ON** to turn it on. Set the 'scope to 1V/div, the timebase to 200 μ s/div, select DC coupling and observe the waveform.

Select the other waveforms in turn (using the **FUNCTION** keys) and observe the differences between **SQUAREWAVE** and **PULSES**; the 'scope trigger may need resetting when changing between waveshapes. Also select **STAIR** and **ARBITRARY** waveshapes to view the default settings.

With **SINE** or **TRIANGLE** selected again, move the flashing edit cursor into the numeric field of the EMF value using the **FIELD** keys. Using the **DIGIT** keys move the cursor through the numeric field to the digit representing $\cdot 1$ V increments, then adjust the amplitude with the **rotary control**. Using the keyboard enter **1, 0, V** to restore the output level to 10Vpp.

Move the cursor to the Symmetry field with the **SYM** key, and observe the effect of adjusting symmetry with the **rotary control**. Restore 50% symmetry by entering **5, 0, %**, from the keyboard.

Pulse Trains

To demonstrate simple pulse waveforms for digital applications, select **+PULSE** and press:

EMF, 4, V
DC OFFSET, 0, ., 8, V
FREQ, 1, kHz.

This setting will give the standard TTL levels of 2.4V and 0.4V (into 50 Ω) as a 1:1 duty cycle 1kHz pulse train.

Move the cursor to the Symmetry field with the **SYM** key and adjust the symmetry with the **rotary control** to create pulses with different mark : space ratios.

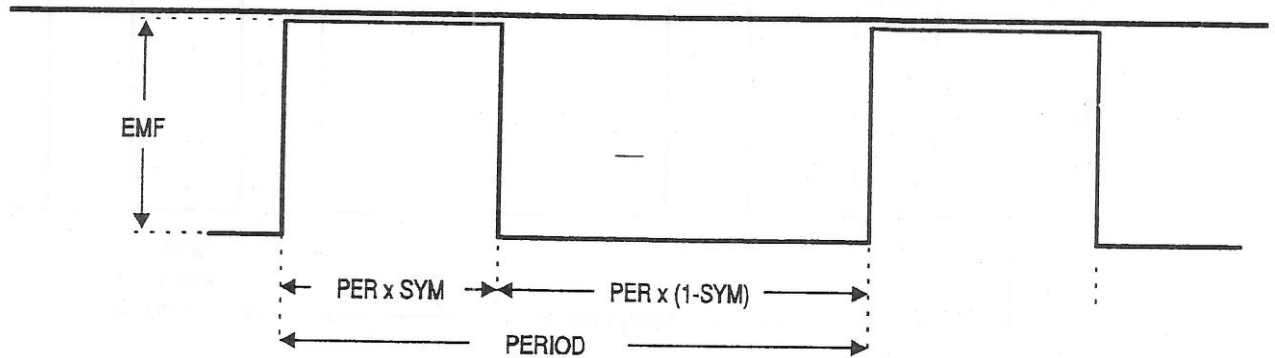

Using this technique the duty cycle range is limited to that achievable with the symmetry control (99:1). For very small duty cycles, at lower repetition rates, the triggering facilities may be used, see next section.

Low Duty Cycle Pulse Trains

These can be created by using the internal trigger generator to produce the long interval between the pulses, with each pulse being a single cycle of the main generator. Set the main generator to 10kHz by pressing **FREQ, 1, 0, kHz**, and reduce the duty-cycle to 1:99 (i.e. pulse width 1 μ s) by pressing **SYM, 1, %**.

Select the Trigger menu by pressing **EDIT, TRIG**, and set **SOURCE = TGEN**, i.e. internal trigger generator. The TGEN period should be at its default setting of 1.00ms (1.000kHz) and the burst count set to 0001. The default phase setting of 0° corresponds to the top of the rising edge of the pulse and starting at this phase will not give the desired result; set the phase to -90° by moving the cursor to the **PHASE** field with the **FIELD** keys and enter **-, 9, 0, ENTER**.

Whilst still in the Trigger menu press **TRIG** again to turn Trigger mode on.

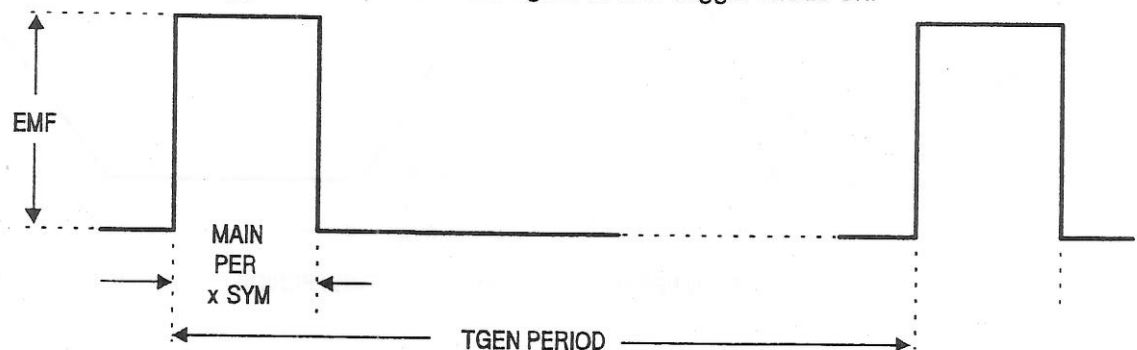

A single cycle of the main generator (i.e. a single pulse) will now be output at the default frequency of 1kHz; a 1000:1 duty cycle has now been achieved. Move the cursor to the TGEN period field with the **FIELD** keys and increase the period using the **rotary control**; although it will be difficult to see on the oscilloscope, the 1 μ s pulsewidth is maintained down to mHz repetition rates, i.e. a very small duty-cycle.

Note that at Main generator frequencies above 30kHz phase control of pulse waveforms is restricted unless waveform generation is in Low Frequency mode, see Waveform Generation Options section; this ultimately limits how narrow a pulse can be generated at very low repetition rates.

Multiple Pulses

Multiple pulse trains are obtained by using the same trigger set-up as above but with the burst count set to the desired number of pulses.

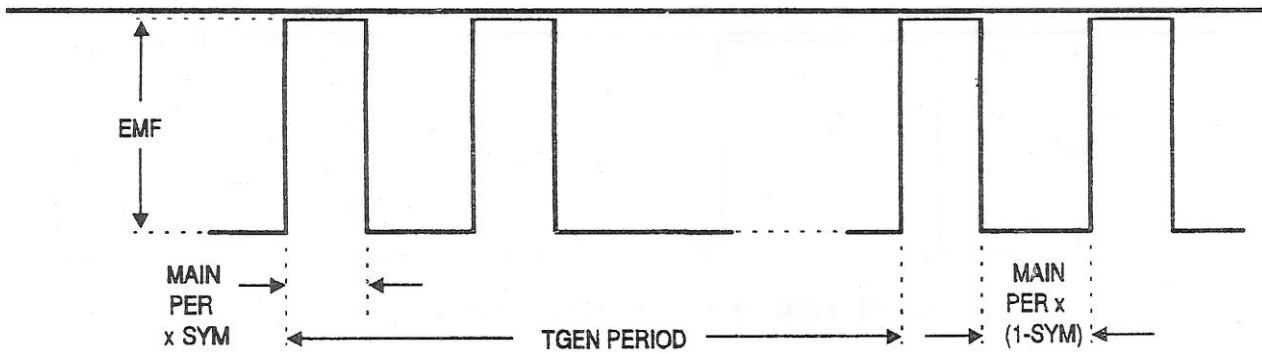

Set TGEN to 1.00ms again (1kHz) and the burst count to 2; this will give the waveform shown. The pulse width and interval between successive pulses is determined by the main generator frequency and symmetry; the pulse width will be PER x SYM and the pulse low time will be PER x (1-SYM). The repetition rate of the bursts remains determined by the TGEN period.

Variable Transition Pulse Waveforms

The half cycle triggered burst capability can be used to produce square waves with a variety of different edge shapes. Three examples are shown, one with straight slew-limited transitions and two with sinusoidal transitions where different start-stop phase settings give quite different effects.

Slew-limited transitions

The edge of slew rate limited pulses are straight lines, produced by half cycles of the main generator triangle wave. The interval between the edges is again defined by the trigger generator.

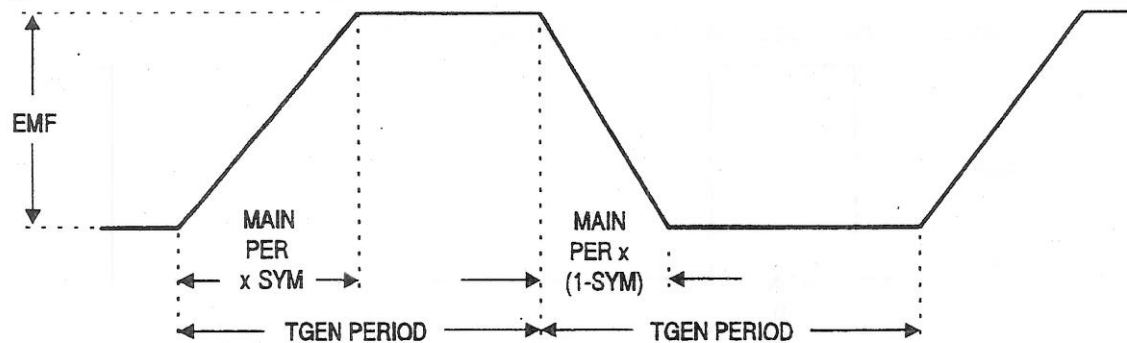

Set the main generator to 10kHz, 10Vpp, by pressing **FREQ, 1, 0, kHz**, and **EMF, 1, 0, V**; change the symmetry to 60:40 by pressing **SYM, 6, 0, %**; **DC OFFSET, 0, V**; select **TRIANGLE**.

Select the Trigger menu by pressing **EDIT, TRIG**, and set **SOURCE=TGEN**, i.e. internal trigger generator. Set the **TGEN** period to 1ms (1.000kHz), the **BURST COUNT** to 000-5 and the **PHASE** to -90°. If it is off, set Trigger mode on by pressing **TRIG** again.

The waveform should be that shown in the diagram. The rise and fall times can be reduced by increasing the main generator frequency and the relationship between rise and fall time can be altered by changing the symmetry.

Band-limited Pulses

The edges of band limited pulses are sinewave segments, starting from -90° . Normally the rise and fall times will be equal, so the main generator symmetry is set to 50%. Following on from the example above:

Set SYM, 5, 0, %

Select SINE

If the trigger parameters have been changed from the above example, re-enter them.

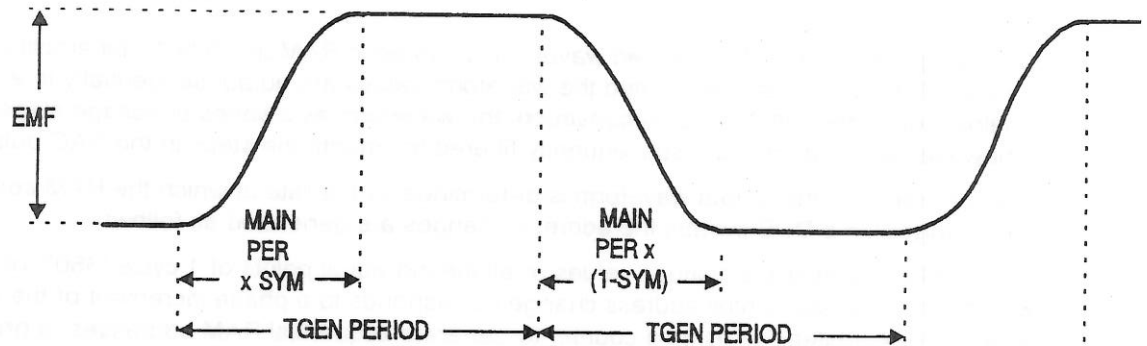

Pulses with Overshoot

The edges and overshoot peaks are sinewaves. The amount of overshoot depends on the starting phase angle which will be from -89° to about 30° . The Main generator amplitude determines the amplitude of the peaks; the amplitude of the flat portions depends on the PHASE.

Following on from the previous examples:

Set FREQ, 2, 0, kHz

Press EDIT, TRIG to select the Trigger menu

Move the edit cursor to the PHASE field and use the rotary control to adjust the phase which will vary the amplitude of the flat portion, creating variable overshoot.

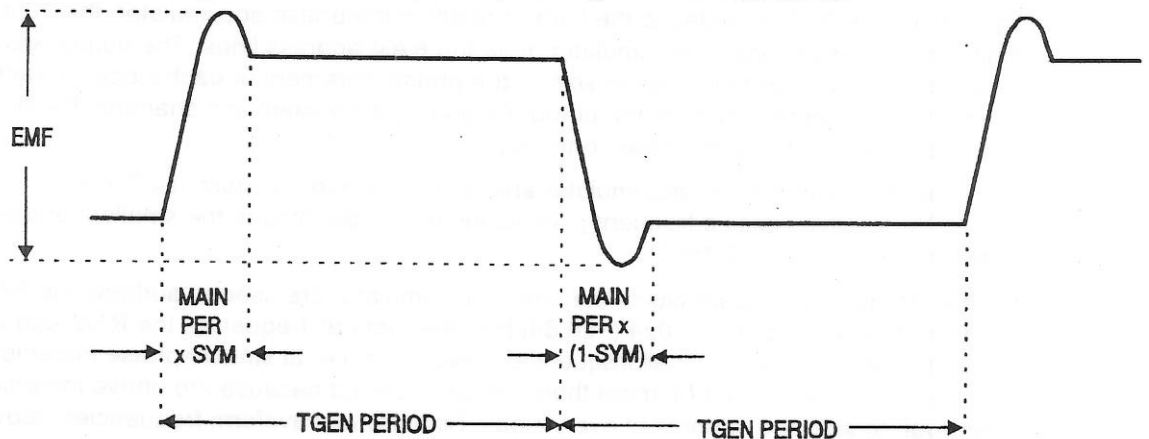

DDS Operation and Further Waveform Considerations

This section gives some further information on DDS operation as a background to understanding both the advantages and limitations of DDS waveform generation.

DDS Operation

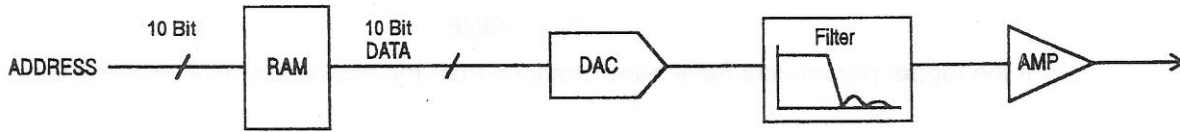

One complete cycle of the selected waveform is stored in RAM as 1024 10-bit amplitude values. As the RAM address is incremented the waveform values are output sequentially to a Digital-to-Analog Converter (DAC) which reconstructs the waveform as a series of voltage steps. Sinewaves and triangles are subsequently filtered to smooth the steps in the DAC output.

The frequency of the output waveform is determined by the rate at which the RAM addresses are changed; in a DDS system the address changes are generated as follows.

The RAM contains the amplitude values of all the individual points of 1 cycle (360°) of the waveform; each sequential address change corresponds to a phase increment of the waveform of $360^\circ/1024$. Instead of using a counter to generate sequential RAM addresses, a **phase accumulator** is used to increment the phase.

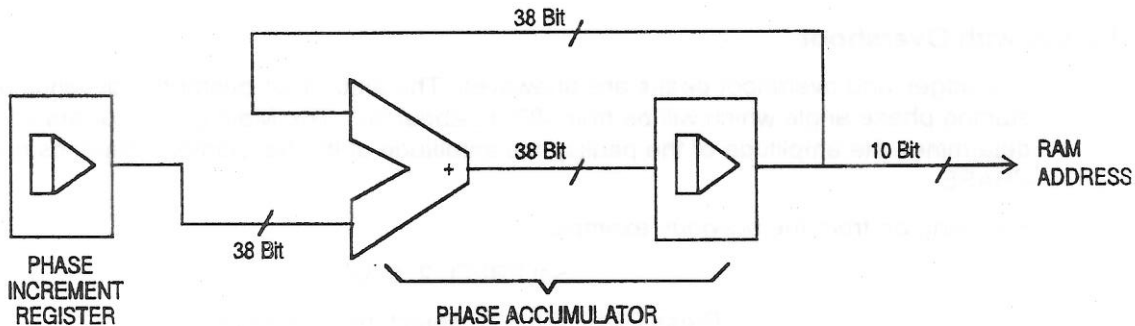

On each clock cycle the phase increment, which has been loaded into the **phase increment register** by the CPU, is added to the current result in the phase accumulator; the 10 most significant bits of the phase accumulator drive the RAM address lines. The output waveform frequency is now determined by the size of the phase increment at each clock. If each increment is the same size then the output frequency is constant; if it changes, the output frequency changes but with phase continuity.

The generator uses a 38-bit accumulator and a clock frequency which is $2^{38} \times 10^{-4}$ (~27.487MHz); this yields a frequency resolution (corresponding to the smallest phase increment) of $f_{CLK}/2^{38} = 0.1\text{mHz}$.

Only the 10 most significant bits of the phase accumulator are used to address the RAM. At a waveform frequency of $f_{CLK}/1024$ (~26.84kHz), the 'natural' frequency, the RAM address increments on every clock. At all frequencies below this (i.e. at smaller phase increments) one or more addresses are output for more than one clock period because the phase increment is not big enough to step the address at every clock. Similarly at waveform frequencies above the natural frequency the larger phase increment causes some addresses to be skipped, giving the effect of the stored waveform being 'sampled'; different points will be sampled on successive cycles of the waveform.

The minimum number of points required to accurately reproduce a waveshape will determine the maximum useful output frequency:

$$f_{max} = f_{CLK}/\text{No. of points}$$

For sinewaves the filter permits the waveform to be reproduced accurately up to the Nyquist limit ($f_{CLK}/2$), although in this generator a practical limit of 10MHz is set.

Further Waveform Considerations

The various limitations on combinations of modes, mostly already mentioned in the appropriate operational sections of the manual, are brought together here and explained with reference to the simplified block diagram below.

Simplified Generator Block Diagram

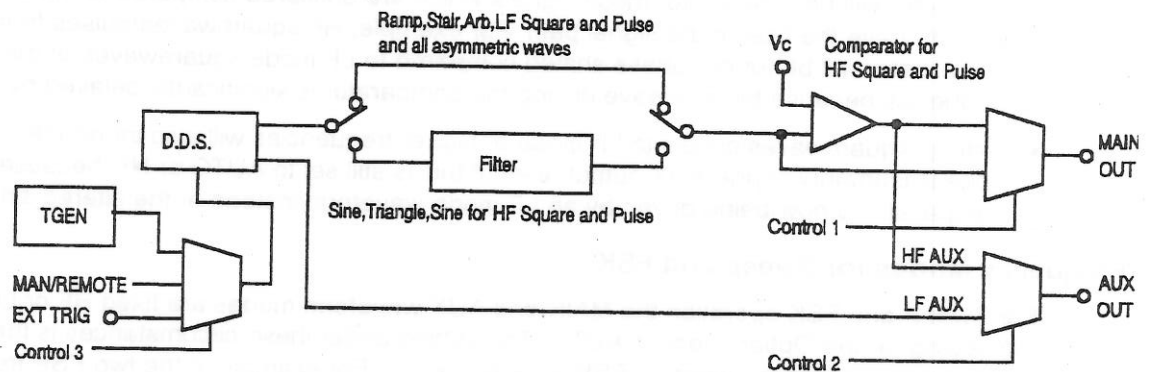

The diagram shows the simplified paths for the main and auxiliary outputs. LF and HF refer to the Low Frequency and High Frequency modes set for Squarewave/pulses and Auxiliary output in the SQWAVE GEN= and AUX= fields of the Options menu, see Waveform Generation Options section. When these fields are set to AUTO the modes automatically change from LF to HF above 30kHz; setting to LF or HF will set that generating mode whatever the generator frequency.

Similarly, when set to AUTO on the Options menu, the Filter will be switched in or out depending on waveform as shown; setting Filter ON or OFF will override this and all or none of the waveforms will be filtered.

Interaction of Various Option Settings

The more important points to consider when setting the Option menu fields to other than AUTO are as follows:

- The comparator which generates MAIN HF squarewaves/pulses is driven, by default, by a filtered sinewave. If the filter is set OFF, the waveform driving the comparator will be poorer and the HF squarewave, etc. will be degraded.
- HF AUX out is generated from the same comparator; the waveform driving the comparator depends on the MAIN waveform selection. For HF squarewave/pulse MAIN outputs the driving waveform is a filtered sinewave as described above; for sinewave and triangle main outputs the comparator drive is the waveform itself (also filtered). The main waveform also drives the comparator for ramp, staircase and arbitrary waveforms plus LF squarewave/pulses, all of which are unfiltered; this means that if the MAIN waveform shows edge jitter as the frequency increases, so will the HF AUX out. For this reason, the default (AUTO) setting for AUX out is LF mode at all frequencies for main waveforms of ramp, staircase, arbitrary and LF squarewaves/pulses.

-
- By default, ramp, staircase, arbitrary and all waveforms whose symmetry is set to other than 50% are unfiltered. It may be desirable to force the filter ON under some circumstances to improve waveform quality, e.g. for higher frequency sinewaves that are only slightly asymmetric.
 - Similarly asymmetric HF squarewaves/pulses and AUX outputs generated from the comparator will be improved if the filter is forced ON to filter the signal driving the comparator.
 - when staircase, arbitrary or LF mode squarewaves/pulses are selected the comparator is driven by the unfiltered main waveform. With all except squarewaves it is possible to have a waveshape which never crosses the comparator threshold, thus HF AUX output may be permanently high or low. To avoid this situation, the default (AUTO) AUX setting is LF mode; however, in this mode edge jitter will become increasingly significant at higher frequencies.
 - Phase shift between MAIN and AUX at higher frequencies (only possible by setting AUX to LF mode) will be different for those signals which are unfiltered compared to those which, by default, have the filter in the signal path. For example, HF squarewaves/pulses from the comparator will be further phase shifted compared to LF mode squarewaves of the same frequency because the sinewave driving the comparator is significantly delayed by the filter.
 - Setting squarewaves/pulses to LF mode at higher frequencies will also introduce 1 clock edge uncertainty on the AUX output, even if this is still set to AUTO or HF, because the comparator is now being driven by an LF mode waveform instead of the filtered sinewave.

Frequency Modes for Sweep and FSK

For Sweep and FSK operation the MAIN and AUX waveform modes are fixed HF or LF even if the setting on the Option menu is AUTO. The setting under these circumstances is that of the main generator before Sweep or FSK were turned on. For example, if the two FSK frequencies are 25kHz and 50kHz and 25kHz was the main generator frequency before FSK was turned on FSK waveforms will be LF mode. In both cases however, the automatic choice can be overridden by selecting HF or LF instead of AUTO in the SQWAVE GEN= and AUX= fields of the Options menu.

Phase-shifted Asymmetric Waveforms

The interaction of symmetry adjustment and start/stop phase of triggered bursts gives waveforms which are difficult to anticipate. In principle, adjusting the symmetry moves the 180° phase point from the 50:50 position of 50% symmetry to, for example, the 40:60 point of 40% symmetry. The 0° - 180° points are now mathematically scaled to fit into 40% of the cycle and 180° - 360° points are interpolated to fit into 60% of the cycle. Start/stop phase still works with the true phase settings but they are not necessarily at the expected point on the waveform, particularly for more complex waveshapes.

Remote Operation

The following sections detail the operation of the instrument via both GPIB and RS232. Where operation is identical no distinction is made between the two. Where differences occur these are detailed in the appropriate sections or in some cases separate sections for GPIB and RS232. It is therefore only necessary to read the general sections and those sections specific to the interface of interest.

Address and Baud Rate Selection

For successful operation each instrument connected to the GPIB or for addressable RS232 must be assigned a unique address and, in the case of addressable RS232, all must be set to the same baud rate.

The instrument's remote address for operation on both the GPIB and RS232 interfaces is set via the REMOTE menu accessed by pressing the REMOTE button.

```
REMOTE=RS232
ADDRESS=05
BAUD RATE=9600
```

With the edit cursor in the REMOTE field, the selected interface can be toggled between RS232 and GPIB with alternate presses of the DIGIT keys, or by using the rotary control.

The address is selected with the edit cursor in the ADDRESS field, using the DIGIT keys or rotary control.

Lastly the baud rate is selected with the edit cursor in the BAUD RATE field, using the DIGIT keys or rotary control.

When operating on the GPIB all device operations are performed through a single primary address; no secondary addressing is used.

NOTE: GPIB address 31 is not allowed by the IEEE 488 standards but it is possible to select it as an RS232 address.

Remote/Local Operation

At power-on the instrument will be in the local state with the REMOTE lamp off. In this state all keyboard operations are possible. When the instrument is addressed to listen and a command is received the remote state will be entered and the REMOTE lamp will be turned on. In this state the keyboard is locked out and remote commands only will be processed. The instrument may be returned to the local state by pressing EDIT which doubles as the LOCAL key; however, the effect of this action will remain only until the instrument is addressed again or receives another character from the interface, when the remote state will once again be entered.

RS232 Interface

RS232 Interface Connections

The 9-way D-type serial interface connector is located on the instrument rear panel. The pin connections are as shown below:

Pin	Name	Description
1	-	No internal Connection
2	TXD	Transmitted data from instrument
3	RXD	Received data to instrument
4	-	No internal connection
5	GND	Signal ground
6	-	No internal connection
7	RXD2	Secondary received data (see diagram)
8	TXD2	Secondary transmitted data (see diagram)
9	GND	Signal ground

Pins 2, 3 and 5 may be used as a conventional RS232 interface with XON/XOFF handshaking. Pins 7, 8 and 9 are additionally used when the instrument is connected for addressable RS232 operation, see below.

Using a simple cable assembly, a 'daisy chain' connection system between any number of instruments, up to the maximum of 32 can be made, as shown below:

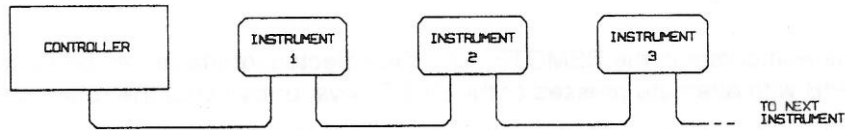

The daisy chain consists of the transmit data (TXD), receive date (RXD) and signal ground lines only. There are no control/handshake lines. This makes XON/XOFF protocol essential and allows the inter-connection between instruments to contain just 3 wires. The wiring of the adaptor cable is shown below:

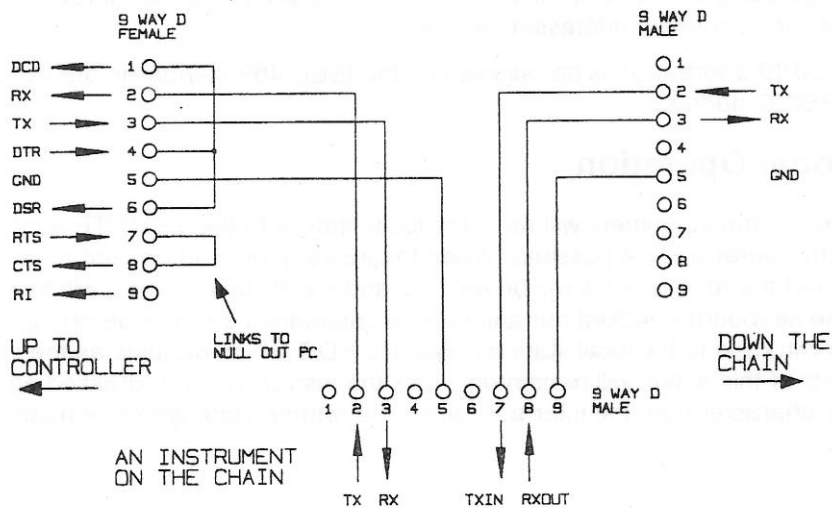

All instruments on the interface must be set to the same baud rate and all must be powered on, otherwise instruments further down the daisy chain will not receive any data or commands.

The other parameters are fixed as follows:

Start bits 1
Data bits 8
Parity None
Stop bits 1

RS232 Character Set

Because of the need for XON/XOFF handshake it is possible to send ASCII coded data only; binary blocks are not allowed. Bit 7 of ASCII codes is ignored, i.e. assumed to be low. No distinction is made between upper and lower case characters in command mnemonics and they may be freely mixed. The ASCII codes below 20H (space) are reserved for interface control.

RS232 Interface Control Codes

All instruments intended for use on the addressable RS232 bus use the following set of interface control codes. Codes between 00H and 1FH which are not listed here as having a particular meaning are reserved for future use and will be ignored. Mixing interface control codes inside instrument commands is not allowed except as stated below for CR and LF codes and XON and XOFF codes.

When an instrument is first powered on it will automatically enter the Non-Addressable mode. In this mode the instrument is not addressable and will not respond to any address commands. This allows the instrument to function as a normal RS232 controllable device. This mode may be locked by sending the Lock Non-Addressable mode control code 04H (LNA). The controller and instrument can now freely use all 8 bit codes and binary blocks but all interface control codes are ignored. To return to addressable mode the instrument must be powered off.

To enable addressable mode after a instrument has been powered on the Set Addressable Mode control code, 02H (SAM), must be sent. This will then enable all instruments connected to the ARC bus to respond to all interface control codes. To return to Non-Addressable mode the Lock Non-Addressable mode control code must be sent which will disable addressable mode until the instruments are powered off.

Before an instrument is sent a command it must be addressed to listen by sending the Listen Address control code, 12H (LAD), followed by a single character which has the lower 5 bits corresponding to the unique address of the required instrument, e.g. the codes A-Z or a-z give the addresses 1-26 inclusive while @ is address 0 and so on. Once addressed to listen the instrument will read and act upon any commands sent until the listen mode is cancelled.

Because of the asynchronous nature of the interface it is necessary for the controller to be informed that an instrument has accepted the listen address sequence and is ready to receive commands. The controller will therefore wait for code 06H (ACK) before sending any commands, The addressed instrument will provide this ACK. The controller should time-out and try again if no ACK is received within 5 seconds.

Listen mode will be cancelled by any of the following interface control codes being received:

12H	LAD	Listen Address followed by an address not belonging to this instrument.
14H	TAD	Talk Address for any instrument.
03H	UNA	Universal Unaddress control code.
04H	LNA	Lock Non-Addressable mode control code.
18H	UDC	Universal Device Clear.

Before a response can be read from an instrument it must be addressed to talk by sending the Talk Address control code, 14H (TAD) followed by a single character which has the lower 5 bits corresponding to the unique address of the required instrument, as for the listen address control code above. Once addressed to talk the instrument will send the response message it has available, if any, and then exit the talk addressed state. Only one response message will be sent each time the instrument is addressed to talk.

Talk mode will be cancelled by any of the following interface control codes being received:

12H	LAD	Listen Address for any instrument.
14H	TAD	Talk Address followed by an address not belonging to this instrument.
03H	UNA	Universal Unaddress control code.
04H	LNA	Lock Non-Addressable mode control code.
18H	UDC	Universal Device Clear.

Talk mode will also be cancelled when the instrument has completed sending a response message or has nothing to say.

The interface code 0AH (LF) is the Universal Command and response Terminator (UCT); it must be the last code sent in all commands and will be the last code sent in all responses.

The interface code 0DH (CR) may be used as required to aid the formatting of commands; it will be ignored by all instruments. Most instruments will terminate responses with CR followed by LF.

The interface code 13H (XOFF) may be sent at any time by a listener (instrument or controller) to suspend the output of a talker. The listener must send 11H (XON) before the talker will resume sending. This is the only form of handshake control supported by ARC.

RS232 Interface Control Code List

02H	SAM	Set Addressable mode.
03H	UNA	Universal Unaddress control code.
04H	LNA	Lock Non-Addressable mode control code.
06H	ACK	Acknowledge that listen address received.
0AH	UCT	Universal Command and response Terminator.
0DH	CR	Formatting code, otherwise ignored.
11H	XON	Restart transmission.
12H	LAD	Listen Address - must be followed by an address belonging to the required instrument.
13H	XOFF	Stop transmission.
14H	TAD	Talk Address - must be followed by an address belonging to the required instrument.
18H	UDC	Universal Device Clear.

GPIB Interface

The GPIB interface is fitted the 24-way GPIB connector is located on the instrument rear panel.

The pin connections are as specified in IEEE Std. 488.1-1987 and the instrument complies with IEEE Std. 488.1-1987 and IEEE Std. 488.2-1987.

GPIB Subsets

This instrument contains the following IEEE 488.1 subsets:

Source Handshake	SH1
Acceptor Handshake	AH1
Talker	T6
Listener	L4
Service Request	SR1
Remote Local	RL1
Parallel Poll	PP1
Device Clear	DC1
Device Trigger	DT1
Controller	C0
Electrical Interface	E2

GPIB IEEE Std. 488.2 Error Handling

The IEEE 488.2 UNTERMINATED error (addressed to talk with nothing to say) is handled as follows. If the instrument is addressed to talk and the response formatter is inactive and the input queue is empty then the UNTERMINATED error is generated. This will cause the Query Error bit to be set in the Standard Event Status Register, a value of 3 to be placed in the Query Error Register and the parser to be reset. See the STATUS REPORTING CAPABILITIES section for further information.

The IEEE 488.2 INTERRUPTED error is handled as follows. If the response formatter is waiting to send a response message and a <PROGRAM MESSAGE TERMINATOR> has been read by the parser or the input queue contains more than one END message then the instrument has been INTERRUPTED and an error is generated. This will cause the Query Error bit to be set in the Standard Event Status Register, a value of 1 to be placed in the Query Error Register and the response formatter to be reset thus clearing the output queue. The parser will then start parsing the next <PROGRAM MESSAGE UNIT> from the input queue. See the STATUS REPORTING CAPABILITIES section for further information.

The IEEE 488.2 DEADLOCK error is handled as follows. If the response formatter is waiting to send a response message and the input queue becomes full then the instrument enters the DEADLOCK state and an error is generated. This will cause the Query Error bit to be set in the Standard Event Status Register, a value of 2 to be placed in the Query Error Register and the response formatter to be reset thus clearing the output queue. The parser will then start parsing the next <PROGRAM MESSAGE UNIT> from the input queue. See the STATUS REPORTING CAPABILITIES section for further information.

GPIB Parallel Poll

Complete parallel poll capabilities are offered on this generator. The Parallel Poll Enable Register is set to specify which bits in the Status Byte Register are to be used to form the *ist* local message. The Parallel Poll Enable Register is set by the *PRE <nrf> command and read by the *PRE? command. The value in the Parallel Poll Enable Register is ANDed with the Status Byte Register; if the result is zero then the value of *ist* is 0 otherwise the value of *ist* is 1.

The instrument must also be configured so that the value of *ist* can be returned to the controller during a parallel poll operation. The instrument is configured by the controller sending a Parallel Poll Configure command (PPC) followed by a Parallel Poll Enable command (PPE). The bits in the PPE command are shown below:

bit 7 =	X	don't care
bit 6 =	1	Parallel poll enable
bit 5 =	1	
bit 4 =	0	
bit 3 =	Sense	sense of the response bit; 0 = low, 1 = high
bit 2 =	?	bit position of the response
bit 1 =	?	
bit 0 =	?	

Example. To return the RQS bit (bit 6 of the Status Byte Register) as a 1 when true and a 0 when false in bit position 1 in response to a parallel poll operation send the following commands

*PRE 64<pmt>, then PPC followed by 69h (PPE)

The parallel poll response from the generator will then be 00h if RQS is 0 and 01h if RQS is 1.

During parallel poll response the DIO interface lines are resistively terminated (passive termination). This allows multiple devices to share the same response bit position in either wired-AND or wired-OR configuration, see IEEE 488.1 for more information.

Power on Settings

The following instrument status values are set at power on:

	Status Byte Register	= 0
*	Service Request Enable Register	= 0
	Standard Event Status Register	= 128 (pon bit set)
*	Standard Event Status Enable Register	= 0
	Execution Error Register	= 0
	Query Error Register	= 0
*	Parallel Poll Enable Register	= 0

*Registers marked thus are specific to the GPIB section of the instrument and are of limited use in an ARC environment.

The instrument will be in local state with the keyboard active.

The instrument parameters at power on are determined by the setting of the POWER UP field on the SYStem menu, see System Menu section. If POWER UP=POWER DOWN or POWER UP=RECALL nn has been set and a defined state is required by the controller at start up then the command *RST should be used to load the system defaults.

If for any reason an error is detected at power up in the non-volatile ram a warning will be issued and all settings will be returned to their default states as for a *RST command.

Status Reporting

This section describes the complete status model of the instrument. Note that some registers are specific to the GPIB section of the instrument and are of limited use in an ARC environment.

Standard Event Status and Standard Event Status Enable Registers

These two registers are implemented as required by the IEEE std. 488.2.

Any bits set in the Standard Event Status Register which correspond to bits set in the Standard Event Status Enable Register will cause the ESB bit to be set in the Status Byte Register.

The Standard Event Status Register is read and cleared by the *ESR? command. The Standard Event Status Enable register is set by the *ESE <nrf> command and read by the *ESE? command.

Bit 7 -	Power On. Set when power is first applied to the instrument.
Bit 6 -	Not used.
Bit 5 -	Command Error. Set when a syntax type error is detected in a command from the bus. The parser is reset and parsing continues at the next byte in the input stream.
Bit 4 -	Execution Error. Set when an error is encountered while attempting to execute a completely parsed command. The appropriate error number will be reported in the Execution Error Register.
Bit 3 -	Not used.
Bit 2 -	Query Error. Set when a query error occurs. The appropriate error number will be reported in the Query Error Register as listed below.
1	Interrupted error
2	Deadlock error
3	Unterminated error
Bit 1 -	Not used.
Bit 0 -	Operation Complete. Set in response to the *OPC command.

Status Byte Register and Service Request Enable Register

These two registers are implemented as required by the IEEE std. 488.2.

Any bits set in the Status Byte Register which correspond to bits set in the Service Request Enable Register will cause the RQS/MSS bit to be set in the Status Byte Register, thus generating a Service Request on the bus.

The Status Byte Register is read either by the *STB? command, which will return MSS in bit 6, or by a Serial Poll which will return RQS in bit 6. The Service Request Enable register is set by the *SRE <nrf> command and read by the *SRE? command.

- Bit 7 - Not used.
- Bit 6 - RQS/MSS. This bit, as defined by IEEE Std. 488.2, contains both the Requesting Service message and the Master Status Summary message. RQS is returned in response to a Serial Poll and MSS is returned in response to the *STB? command.
- Bit 5 - ESB. The Event Status Bit. This bit is set if any bits set in the Standard Event Status Register correspond to bits set in the Standard Event Status Enable Register.
- Bit 4 - MAV. The Message Available Bit. This will be set when the instrument has a response message formatted and ready to send to the controller. The bit will be cleared after the Response Message Terminator has been sent.
- Bit 3 - Not used.
- Bit 2 - Not used.
- Bit 1 - Not used.
- Bit 0 - Not used.

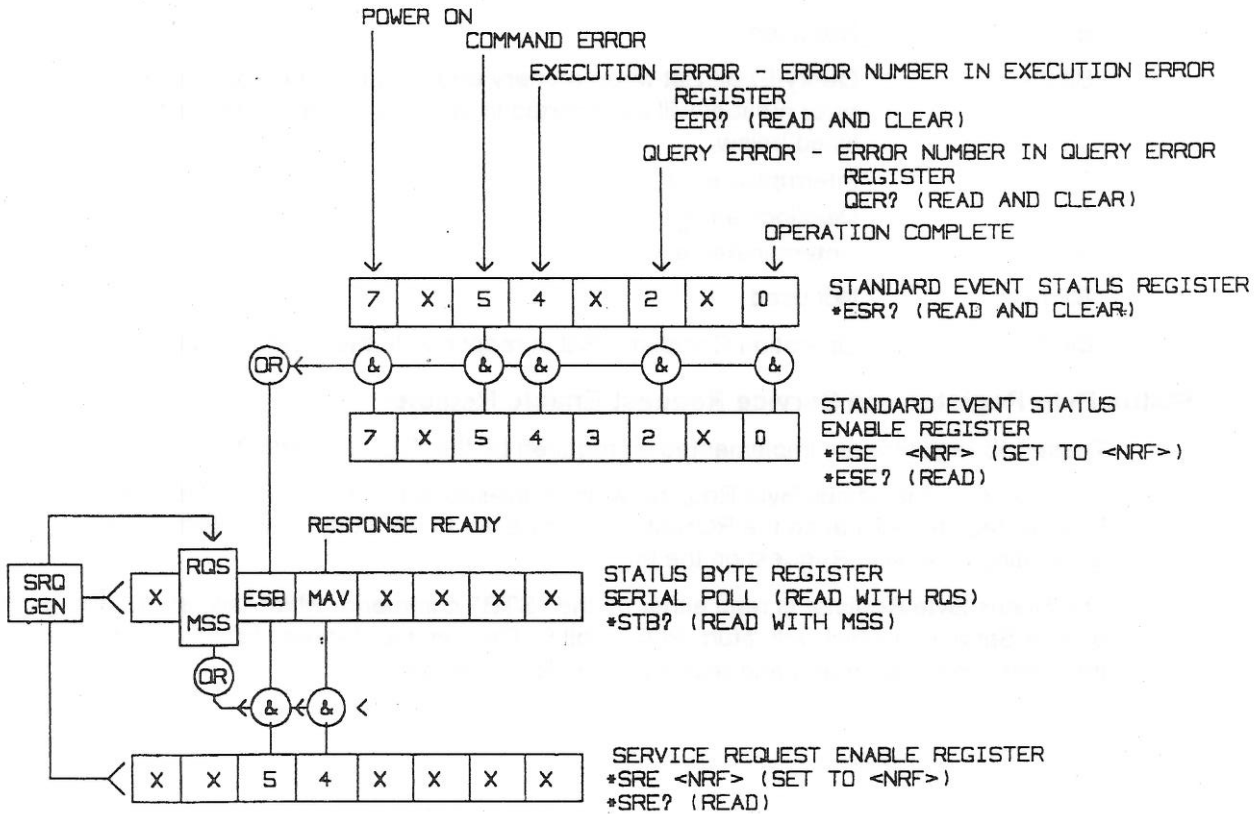

Status Model

RS232 Remote Command Formats

Serial input to the instrument is buffered in a 256 byte input queue which is filled, under interrupt, in a manner transparent to all other instrument operations. The instrument will send XOFF when approximately 200 characters are in the queue. XON will be sent when approximately 100 free spaces become available in the queue after XOFF was sent. This queue contains raw (un-parsed) data which is taken, by the parser, as required. Commands (and queries) are executed in order and the parser will not start a new command until any previous command or query is complete. There is no output queue which means that the response formatter will wait, indefinitely if necessary, until the instrument is addressed to talk and the complete response message has been sent, before the parser is allowed to start the next command in the input queue.

Commands are sent as <PROGRAM MESSAGES> by the controller, each message consists of zero or more <PROGRAM MESSAGE UNIT> elements separated by <PROGRAM MESSAGE UNIT SEPARATOR> elements.

<PROGRAM MESSAGES> are separated by <PROGRAM MESSAGE TERMINATOR> elements which consist of the new line character (0AH).

A <PROGRAM MESSAGE UNIT SEPARATOR> is the semi-colon character ';' (3BH).

A <PROGRAM MESSAGE UNIT> is any of the commands in the REMOTE COMMANDS section.

Responses from the instrument to the controller are sent as <RESPONSE MESSAGES>. A <RESPONSE MESSAGE> consists of one <RESPONSE MESSAGE UNIT> followed by a <RESPONSE MESSAGE TERMINATOR>.

A <RESPONSE MESSAGE TERMINATOR> is the carriage return character followed by the new line character (0DH 0AH).

Each query produces a specific <RESPONSE MESSAGE> which is listed along with the command in the REMOTE COMMANDS section.

<WHITE SPACE> is ignored except in command identifiers. e.g. '*C LS' is not equivalent to '*CLS'. <WHITE SPACE> is defined as character codes 00H to 20H inclusive with the exception of the codes specified as ARC interface commands.

The high bit of all characters is ignored.

The commands are case insensitive.

GPIB Remote Command Formats

GPIB input to the instrument is buffered in a 256 byte input queue which is filled, under interrupt, in a manner transparent to all other instrument operations. The queue contains raw (un-parsed) data which is taken, by the parser, as required. Commands (and queries) are executed in order and the parser will not start a new command until any previous command or query is complete. There is no output queue which means that the response formatter will wait, indefinitely if necessary, until the instrument is addressed to talk and the complete response message has been sent, before the parser is allowed to start the next command in the input queue.

Commands are sent as <PROGRAM MESSAGES> by the controller, each message consists of zero or more <PROGRAM MESSAGE UNIT> elements separated by <PROGRAM MESSAGE UNIT SEPARATOR> elements.

<PROGRAM MESSAGES> are separated by <PROGRAM MESSAGE TERMINATOR> elements which may be any of the following:

NL	The new line character (0AH)
NL^END	The new line character with the END message
^END	The END message with the last character of the message

A <PROGRAM MESSAGE UNIT SEPARATOR> is the semi-colon character ';' (3BH).

A <PROGRAM MESSAGE UNIT> is any of the commands in the REMOTE COMMANDS section.

Responses from the instrument to the controller are sent as <RESPONSE MESSAGES>. A <RESPONSE MESSAGE> consists of one <RESPONSE MESSAGE UNIT> followed by a <RESPONSE MESSAGE TERMINATOR>.

A <RESPONSE MESSAGE TERMINATOR> is the new line character with the END message NL^END.

Each query produces a specific <RESPONSE MESSAGE> which is listed along with the command in the REMOTE COMMANDS section.

<WHITE SPACE> is ignored except in command identifiers. e.g. '*C LS' is not equivalent to '*CLS'. <WHITE SPACE> is defined as character codes 00H to 20H inclusive with the exception of the NL character (0AH).

The high bit of all characters is ignored.

The commands are case insensitive.

Remote Commands

The following section lists all commands and queries implemented in this instrument. For ease of use, commands are grouped to match the display menus. The REMOTE COMMAND SUMMARY lists the commands in alphabetical order, for reference.

Note that there are no dependent parameters, coupled parameters, overlapping commands, expression program data elements or compound command program headers and that each command is completely executed before the next command is started. All commands are sequential and the operation complete message is generated immediately after execution in all cases.

The following nomenclature is used:

<pmt>	<PROGRAM MESSAGE TERMINATOR>
<rmt>	<RESPONSE MESSAGE TERMINATOR>
<cpd>	<CHARACTER PROGRAM DATA>, i.e. a short mnemonic or string such as ON or OFF.
<nrf>	A number in any format. e.g. 12, 12.00, 1.2 e1 and 120 e-1 are all accepted as the number 12. Any number, when received, is converted to the required precision consistent with the use then rounded up to obtain the value of the command.
<nr1>	A number with no fractional part, i.e. an integer.
<nr2>	A number in fixed point format, e.g. 11.52, 0.78 etc.
[...]	Any item(s) enclosed in these brackets are optional parameters. If more than one item is enclosed then all or none of the items are required.

The commands which begin with a * are those specified by IEEE Std. 488.2 as Common commands. All will function when used on the RS232 interface but some are of little use.

Function Selection

SINE	Set sine function
SQUARE	Set square function
TRIAN	Set triangle function
POSPUL	Set positive pulse function
NEGPUL	Set negative pulse function
POSRAMP	Set positive ramp function
NEGRAMP	Set negative ramp function
STAIR	Set staircase function
ARB	Set arbitrary function
NOISE <cpd>	Set NOISE <ON> or <OFF>

Main Generator Parameters

OUTPUT <cpd>	Set output <ON>, <OFF>, <NORMAL> or <INVERT>
FREQ <nrf>	Set main frequency to <nrf> Hz
PER <nrf>	Set main period to <nrf> seconds
EMFPP <nrf>	Set output level to <nrf> Vpp open circuit (i.e. VhiZ)
EMFRMS <nrf>	Set output level to <nrf> Vrms open circuit (i.e. VhiZ)
PDPP <nrf>	Set output level to <nrf> Vpp terminated (i.e. V)
PDRMS <nrf>	Set output level to <nrf> Vrms terminated (i.e. V)
DBM (nrf)	Set output level to <nrf> dBm terminated
ZOUT <nrf>	Set output impedance to <nrf>; only 50 or 600 are legal.
DCOFFS <nrf>	Set dc offset to <nrf> Volts
SYMM <nrf>	Set symmetry to <nrf> %
PHASE <nrf>	Set phase to <nrf> degrees

Sweep Parameters

SWEEP <cpd>	Set sweep mode to <ON> or <OFF>
SWPBEGFRQ <nrf>	Set sweep begin frequency to <nrf> Hz
SWPBEGPER <nrf>	Set sweep begin period to <nrf> seconds
SWPENDFRQ <nrf>	Set sweep end frequency to <nrf> Hz
SWPENDPER <nrf>	Set sweep end period to <nrf> seconds
SWPMKRFRQ <nrf>	Set sweep marker frequency to <nrf> Hz
SWPMKRPER <nrf>	Set sweep marker period to <nrf> seconds
SWPMODE <cpd>	Set sweep mode to <BTOE> (begin to end) or <ETOB> (end to begin)
SWPLAW <cpd>	Set sweep law to <LOG> or <LIN>
SWPTIME <nrf>	Set sweep time to <nrf> seconds
SWPSRC <cpd>	Set sweep source to <CONT> (continuous), <EXT> (external) or <MAN> (manual)
*TRG	Executes a trigger which will have the same effect as pressing the MAN/SYNC key. MAN/REMOTE trigger source must be selected first. GPIB Group Execute Trigger command (GET) will perform the same function as *TRG.

Trigger and Gate

TRIG <cpd>	Set trigger mode to <ON> or <OFF>
-------------------	-----------------------------------

GATE <cpd>	Set gate mode to <ON> or <OFF>
TRIGSRC <cpd>	Set trigger source to <EXT>, <MAN> or <TGEN>
GATESRC <cpd>	Set gate source to <EXT>, <MAN> or <TGEN>
TGEN <nrf>	Set trigger generator period to <nrf> seconds
BCNT <nrf>	Set burst count to <nrf> cycles
PHASE <nrf>	Set phase to <nrf> degrees
*TRG	Executes a trigger which will have the same effect as pressing the MAN/SYNC key. MAN/REMOTE trigger source must be selected first. GPIB Group Execute Trigger command (GET) will perform the same function as *TRG.

AM Parameters

AM <cpd>	Set AM mode to <ON> or <OFF>
AMSRC <cpd>	AM source to <EXT> or <TGEN>
TGEN <nrf>	Set trigger generator period to <nrf> seconds
AMDEPTH <nrf>	Set internal AM depth to <nrf> %
AMWAVE <cpd>	Set internal AM wave to <SINE> or <SQUARE>

FSK Parameters

FSK <cpd>	Set FSK mode to <ON> or <OFF>
FSKFRQA <nrf>	Set main generator frequency to <nrf> Hz (for completeness only)
FSKPERA <nrf>	Set main generator period to <nrf> seconds (for completeness only)
FSKFRQB <nrf>	Set FSK frequency B to <nrf> Hz
FSKPERB <nrf>	Set FSK period B to <nrf> seconds
FSKSRC <cpd>	Set FSK source to <EXT>, <MAN> or <TGEN>
TGEN <nrf>	Set trigger generator period to <nrf> seconds
*TRG	Executes a trigger which will have the same effect as pressing the MAN/SYNC key. MAN/REMOTE trigger source must be selected first. GPIB Group Execute Trigger command (GET) will perform the same function as *TRG.

Staircase and Arbitrary Waveforms

STAIR	Set staircase function
SETSTAIR <nrf>,...<nrf>	Define a new staircase function. Up to 16 pairs of length and level may be specified; valid length range 0000 to 1024, valid level -512 to +511.
ARB	Set arbitrary function

SETARB <nrf>,...<nrf>	Define a new Arbitrary function. 1024 values must be specified to set the waveform, each one a level in the range -512 to +511.
ARBSAV <nrf>, <cpd>	Save arbitrary waveform to store <nrf> with name <character data>. The maximum length of the name is 16 characters. N.B. If it is required to retain a waveform sent by a SETARB command, ARBSAV must be used immediately after SETARB. If this is not done, any other 'ARB' operation except ARB will will destroy the data. The waveform data will also be lost at power down unless it is saved first.
ARBRCL <nrf>	Recall arbitrary waveform from store <nrf>
ARB?	Query the selected arbitrary waveform; responds SETARB <1024 nr1>><rmt>

Waveform Generation Options

SQRWAVGEN <cpd>	Set squarewave generation mode to <AUTO>,<HF>or<LF>
FILTER <cpd>	Set filter mode to <AUTO>,<ON> or <OFF>
AUX <cpd>	Set AUX output mode to <AUTO>,<HF> or <LF>
SWPTRGOUT <cpd>	Set sweep/tgen output bnc mode to <AUTO>,<SWEEP>or<TGEN>

HOP Commands

HOP <cpd>,<nrf>	Set HOP status to <RUN> or <OFF> with last step set to <nrf>.
SETHOP <nrf>,<nrf>,<nrf>,<nrf>,<cpd>,<nrf>	Data for one step in the sequence : <step>,<time>,<freq>,<level>,<func>,<offset>. <step> is the step number to be defined. <time> is the time in seconds to remain in this step. If set to 0 MANUAL will be selected. If set to 1e-3 EXTERNAL will be selected. <freq> is the main generator frequency in Hz. <level> is the output level expressed in EMF Vpp. <func> is any of <SINE>,<SQUARE>,<TRIANG>,<POSPUL>,<NEGPUL>,<POSRAMP>,<NEGRAMP>,<STAIR> or <ARB>. <offset> is the DC Offset in Volts.
*TRG	Executes a trigger which will have the same effect as pressing the MAN/SYNC key. MAN/REMOTE trigger source must be selected first. GPIB Group Execute Trigger command (GET) will perform the same function as *TRG.

System Commands

BEEPMODE <cpd>	Set beep mode to <ON>,<OFF>,<WARN> or <ERROR>
BEEP	Sound one beep.
*RCL <nrf>	Recalls the instrument set up contained in store number <nrf>. Valid store numbers are 0 - 9. Recalling store 0 sets all parameters to the default settings (see DEFAULT INSTRUMENT SETTINGS)..
*RST	Resets the instrument parameters to their default values (see DEFAULT INSTRUMENT SETTINGS).

***SAV <nrf>** Saves the complete instrument set up in the store number <nrf>. Valid store numbers are 1 - 9.

Status Commands

***LRN?** Returns the complete set up of the instrument as a hexadecimal character data block approximately 842 bytes long. To re-install the set up the block should be returned to the instrument exactly as it is received. The syntax of the response is LRN <Character data><rmt>. The settings in the instrument are not affected by execution of the *LRN? command.

LRN <character data> Install data for a previous *LRN? command.

EER? Query and clear execution error number register. The response format is nr1<rmt>.

QER? Query and clear query error number register. The response format is nr1<rmt>

***CLS** Clear status. Clears the Standard Event Status Register, Query Error Register and Execution Error Register. This indirectly clears the Status Byte Register.

***ESE <nrf>** Set the Standard Event Status Enable Register to the value of <nrf>.

***ESE?** Returns the value in the Standard Event Status Enable Register in <nr1> numeric format. The syntax of the response is <nr1><rmt>

***ESR?** Returns the value in the Standard Event Status Register in <nr1> numeric format. The register is then cleared. The syntax of the response is <nr1><rmt>

***IST?** Returns ist local message as defined by IEEE Std. 488.2. The syntax of the response is 0<rmt>, if the local message false or 1<rmt>, if the local message is true.

***OPC** Sets the Operation Complete bit (bit 0) in the Standard Event Status Register. This will happen immediately the command is executed because of the sequential nature of all operations.

***OPC?** Query operation complete status. The syntax of the response is 1<rmt>. The response will be available immediately the command is executed because of the sequential nature of all operations.

***PRE <nrf>** Set the Parallel Poll Enable Register to the value <nrf>.

***PRE?** Returns the value in the Parallel Poll Enable Register in <nr1> numeric format. The syntax of the response is <nr1><rmt>

***SRE <nrf>** Set the Service Request Enable Register to <nrf>. If the value of <nrf>.

***SRE?** Returns the value of the Service Request Enable Register in <nr1> numeric format. The syntax of the response is <nr1><rmt>

***STB?** Returns the value of the Status Byte Register in <nr1> numeric format. The syntax of the response is <nr1><rmt>

***WAI** Wait for operation complete true. As all commands are completely executed before the next is started this command takes no additional action.

Miscellaneous Commands

- *IDN?** Returns the instrument identification. The exact response is determined by the instrument configuration and is of the form <NAME>, <model>, 0, <version><rmt>where <NAME> is the manufacturer's name, <MODEL> defines the type of instrument and <VERSION> is the revision level of the software installed.
- *TST?** The generator has no self-test capability and the response is always 0<rmt>

Phase Locking Commands

- *TRG** Executes a trigger which will have the same effect as pressing the MAN/SYNC key. GPIB Group Execute Trigger command (GET) will perform the same function as *TRG.
- CLOCKBNC <cpd>** Set clock bnc mode to <OUTPUT>, <INPUT> or <SLAVE> (phase lock)
- ABORT** Abort on unsuccessful phase locking operation. If no operation was in progress the command is ignored. If an operation is aborted then error 136 is placed in the execution error register.

Remote Command Summary

*ESE <nrf>	Set the Standard Event Status Enable Register to the value of <nrf>.
*ESE?	Returns the value in the Standard Event Status Enable Register in <nr1> numeric format.
*ESR?	Returns the value in the Standard Event Status Register in <nr1> numeric format.
*IDN?	Returns the instrument identification.
*IST?	Returns ist local message as defined by IEEE Std. 488.2.
*LRN?	Returns the complete set up of the instrument as a hexadecimal character data block approximately 842 bytes long.
*PRE <nrf>	Set the Parallel Poll Enable Register to the value <nrf>.
*PRE?	Returns the value in the Parallel Poll Enable Register in <nr1> numeric format.
*RCL <nrf>	Recalls the instrument set up contained in store number <nrf>.
*RST	Resets the instrument parameters to their default values.
*SAV <nrf>	Saves the complete instrument set up in the store number <nrf>.
*SRE <nrf>	Set the Service Request Enable Register to <nrf>. If the value of <nrf>.
*SRE?	Returns the value of the Service Request Enable Register in <nr1> numeric format.
*STB?	Returns the value of the Status Byte Register in <nr1> numeric format.
*TRG	Executes a trigger which will have the same effect as pressing the MAN/SYNC key.
*TST?	The generator has no self-test capability and the response is always 0<rrmt>
*WAI	Wait for operation complete true.
ABORT	Abort on unsuccessful phase locking operation.
AM <cpd>	Set AM mode to <ON> or <OFF>
AMDEPTH <nrf>	Set internal AM depth to <nrf> %
AMSRC <cpd>	AM source to <EXT> or <TGEN>
AMWAVE <cpd>	Set internal AM wave to <SINE> or <SQUARE>
ARB	Set arbitrary function
ARB	Set arbitrary function
ARB?	Query the selected arbitrary waveform.
ARBRCCL<nrf>	Recall arbitrary waveform from store <nrf>
ARBSAV <nrf>, <cpd>	Save arbitrary waveform to store <nrf> with name <character data>.

AUX <cpd>	Set AUX output mode to <AUTO>, <HF> or <LF>
BCNT <nrf>	Set burst count to <nrf> cycles
BEEP	Sound one beep.
BEEPMODE <cpd>	Set beep mode to <ON>, <OFF>, <WARN> or <ERROR>
CLOCKBNC <cpd>	Set clock bnc mode to <OUTPUT>, <INPUT> or <SLAVE> (phase lock)
DBM (nrf>	Set output level to <nrf> dBm terminated
DCOFFS <nrf>	Set dc offset to <nrf> Volts
EER?	Query and clear execution error number register.
EMFPP <nrf>	Set output level to nrf Vpp open circuit
EMFRMS <nrf>	Set output level to <nrf> Vrms open circuit
FILTER <cpd>	Set filter mode to <AUTO>, <ON> or <OFF>
FREQ <nrf>	Set main frequency to <nrf> Hz
FSK <cpd>	Set FSK mode to <ON> or <OFF>
FSKFRQA <nrf>	Set main generator frequency to <nrf> Hz (for completeness only)
FSKFRQB <nrf>	Set FSK frequency B to <nrf> Hz
FSKPERA <nrf>	Set main generator period to <nrf> seconds (for completeness only)
FSKPERB <nrf>	Set FSK period B to <nrf> seconds
FSKSRC <cpd>	Set FSK source to <EXT>, <MAN> or <TGEN>
GATE <cpd>	Set gate mode to <ON> or <OFF>
GATESRC <cpd>	Set gate source to <EXT>, <MAN> or <TGEN>
HOP <cpd>, <nrf>	Set HOP status to <RUN> or <OFF> with last step set to <nrf>.
LRN <character data>	Install data for a previous *LRN? command.
NEGPUL	Set negative pulse function
NEGRAMP	Set negative ramp function
NOISE <cpd>	Set NOISE <ON> or <OFF>
OUTPUT <cpd>	Set output <ON>, <OFF>, <NORMAL> or <INVERT>
PDPP <nrf>	Set output level to <nrf> Vpp terminated
PDRMS <nrf>	Set output level to <nrf> Vrms terminated
PER <nrf>	Set main period to <nrf> seconds
PHASE <nrf>	Set phase to <nrf> degrees
PHASE <nrf>	Set phase to <nrf> degrees
POSPUL	Set positive pulse function

POSRAMP	Set positive ramp function
SETARB <nrf>,...<nrf>	Define a new Arbitrary function.
SETHOP <nrf>,<nrf>, <nrf>,<nrf>,<cpd>,<nrf>	Data for one step in the sequence .
SETSTAIR <nrf>,...<nrf>	Define a new staircase function.
SINE	Set sine function
SQRWAVGEN <cpd>	Set squarewave generation mode to <AUTO>,<HF>or<LF>
SQUARE	Set square function
STAIR	Set staircase function
STAIR	Set staircase function
SWEEP <cpd>	Set sweep mode to <ON> or <OFF>
SWPBEGFRQ <nrf>	Set sweep begin frequency to <nrf> Hz
SWPBEGPER <nrf>	Set sweep begin period to <nrf> seconds
SWPENDFRQ <nrf>	Set sweep end frequency to <nrf> Hz
SWPENDPER <nrf>	Set sweep end period to <nrf> seconds
SWPLAW <cpd>	Set sweep law to <LOG> or <LIN>
SWPMKRFRQ <nrf>	Set sweep marker frequency to <nrf> Hz
SWPMKRPER <nrf>	Set sweep marker period to <nrf> seconds
SWPMODE <cpd>	Set sweep mode to <BTOE> (begin to end) or <ETOB> (end to begin)
SWPSRC <cpd>	Set sweep source to <CONT> (continuous), <EXT> (external) or <MAN> (manual)
SWPTIME <nrf>	Set sweep time to <nrf> seconds
SWPTRGOUT <cpd>	Set sweep/tgen output bnc mode to <AUTO>,<SWEEP>or<TGEN>
SYMM <nrf>	Set symmetry to <nrf> %
TGEN <nrf>	Set trigger generator period to <nrf> seconds
TGEN <nrf>	Set trigger generator period to <nrf> seconds
TGEN <nrf>	Set trigger generator period to <nrf> seconds
TRIAN	Set triangle function
TRIG <cpd>	Set trigger mode to <ON> or <OFF>
TRIGSRC <cpd>	Set trigger source to <EXT>,<MAN> or <TGEN>
ZOUT <nrf>	Set output impedance to <nrf>; only 50 or 600 are legal.

Appendix 1. Warning and Error Messages

Warning messages are given when a setting may not give the expected result, e.g. DC Offset attenuated by the output attenuator when a small amplitude is set; the setting is, however, implemented.

Error messages are given when an illegal setting is attempted; the previous setting is retained.

The last two warning/error messages can be reviewed by pressing EDIT followed by MSG (the shifted function of 0), the latest is reported first.

Warning and error messages are reported with a number on the display; only the number is reported via the remote control interfaces.

The following is a complete list of messages as they appear on the screen. In most cases they are self-explanatory but where doubt may arise some further explanation is given.

Warning Messages

- 00 No errors or Warns have been reported.
- 07 DC Offset change by Output level
- 09 Symmetry too wide for func/freq
- 10 Symmetry changed by function/freq
- 11 DC Offset atten by Output level
- 14 Trigger Generator max res 20us
- 17 Phase angle change by function/freq
- 20 This instrument is not calibrated
- 22 Operation is illegal here.

This warning is used when certain key entries are attempted during operations where they are not permitted. Such operations include:

- The instrument is a synchronous slave
- Edit modes of STAIR and ARB
- HOP mode selected
- Noise selected

Full explanations of the restrictions will be found in the appropriate operational sections of the manual.

- 23 Mode illegal when synchronous slave
- 24 Burst time exceeds TGEN period
- 25 DC Offset + level may cause clipping

Error Messages

- 101 Frequency/Period Val out of range
- 102 Max Output level exceeded
- 103 Min Output level exceeded
- 104 Requested units are illegal here
- 105 Min DC Offset exceeded
- 106 Max DC Offset exceeded

108	Symmetry value is illegal
112	Trigger generator period too big
113	Trigger generator period too small
115	Burst count value out of range
116	Phase angle value out of range
118	Trigger generator fixed by am sine
119	Mod depth value out of range
121	System ram error battery flat?
126	Sweep time is too long
127	Sweep time is too short
128	No GPIB interface is available
134	Illegal HOP step number requested
135	HOP time value out of range
136	Unable to phase lock to master

Error Messages - Remote Control Only

The following messages are only relevant to remote control operation.

129	Illegal store number requested
130	Byte value outside the range 0 to 255
131	Illegal value in staircase data
132	Illegal ARB store
133	Illegal value in arbitrary data

Appendix 2. Factory System Defaults

The factory system defaults are listed in full below. They can be recalled by pressing Recall, 0, Enter or by the remote command *RST.

Main Menu Parameters

Frequency: 10kHz
Output: 20Vpp EMF ; Output OFF
Zout: 50Ω
DC Offset: 0V
Symmetry: 50%

Trigger Parameters

Source: EXT
TGEN: 1ms
Burst Count: 1
Phase: 0°

Gate Parameters

Source: EXT
TGEN 1ms

FSK Parameters

Freq A 10kHz
Freq B 10MHz
Source EXT
TGEN 1ms

AM Parameters

Source: EXT VCA
TGEN: 1ms
Internal Mod Depth: 30%
Internal Mod Wave: Square

STAIR Parameters

Symmetrical 3-level squarewave, maximum amplitude.

ARB Parameters

Default waveform from store 14, i.e. $\sin x/x$.

Sweep Parameters

Begin frequency: 100kHz
End frequency: 10MHz
Marker frequency: 5MHz
Mode: Being to End

Law: Log
Ramp time: 50ms
Trig Source: Continuous

Noise

Noise Off

Hop Parameters

Hop Off

All parameters are unaffected by Recall 0 or *RST except Last Step which is set to 01.

